



TECHNICAL SERVICE GUIDE

Arctica/Profile/GE Side-by-Side Refrigerators with Electronic Touch Controls



MODEL SERIES:

PSS and GSS

23, 25, 27, and 29 inch





IMPORTANT SAFETY NOTICE

The information in this service guide is intended for use by individuals possessing adequate backgrounds of electrical, electronic, and mechanical experience. Any attempt to repair a major appliance may result in personal injury and property damage. The manufacturer or seller cannot be responsible for the interpretation of this information, nor can it assume any liability in connection with its use.

WARNING

To avoid personal injury, disconnect power before servicing this product. If electrical power is required for diagnosis or test purposes, disconnect the power immediately after performing the necessary checks.

RECONNECT ALL GROUNDING DEVICES

If grounding wires, screws, straps, clips, nuts, or washers used to complete a path to ground are removed for service, they must be returned to their original position and properly fastened.

GE Consumer Home Services Training
Technical Service Guide
Copyright © 2001

All rights reserved. This service guide may not be reproduced in whole or in part in any form without written permission from the General Electric Company.

Table of Contents

Introduction	2
Installation	3
Specifications	4
Nomenclature	5
Warranty Information	6
Operating Characteristics	7
General Locator Views	14
Mechanical Disassembly	16
Diagnostics	32
Component and Connector Locator Views	55
Schematics	61
Illustrated Parts Catalog	63

Introduction

2001 Energy SxS models are being introduced in response to the requirement for more energy-efficient refrigerators by mid year 2001, along with feature and operation enhancements. The primary differences in this refrigeration system are the adaptive defrost system (see Pub # 31-9062), control board, software, and control systems that operate independently in fresh food and freezer sections. The new high-efficiency control system has the ability to cycle components and adjust fan speeds as required to maintain temperature-setting ranges in fresh food and freezer sections. Feedback systems are digital inputs and relay outputs. Sensors (thermistors) are used to measure temperature with communications to a main PC board, which controls the unit components.

The Refrigerator has touchpad controls to provide inputs to a microprocessor. The fresh food and freezer controls are temperature setpoint type and have settings of 0-9 with 9 being the coldest temperature possible. The new NO CLEAN condenser is serviceable from the rear and is designed to prevent the customer from having to clean the condenser in normal usage conditions.

Sealed system operation and compressor are functionally the same as previous models, with some minor changes.

The Profile Performance and Arctica side by side models are the models affected. These models are available with a through-the-door chilled water and ice dispenser, and a built-in water filter feature. On models requiring icemaker, the newest electronic icemaker (see Pub. # 31-9063) has been or can be installed.

The freezer has adjustable shelves, a slide-out Spillproof shelf, a QuickSpace shelf, and deep door shelves, based on the model. The fresh food section has a baking soda holder, a fruit and vegetable drawer, drawer dividers, an adjustable humidity drawer, and a convertible meat drawer.

The new high-efficiency refrigerator is a combination of the most efficient refrigeration system and the most desirable customer features available.



Installation

1

Use padded hand truck to protect refrigerator finish. LEAVE TAPE ON DOORS until refrigerator is in its final location. TRUCK FROM SIDE ONLY. Avoid overtightening strap to prevent damaging doors.

2

REMOVE ALL CLEAR PROTECTIVE TAPE FROM TRIMS, then move unit into position. If entrance is less than 38" wide, remove doors prior to installation and reinstall doors according to procedure below.

3

Connect water lines and power cord. ADJUST FRONT ROLLERS so the refrigerator is solid on floor and doors close easily. MAKE SURE DOORS ARE EVEN AT TOP.

4 **5** **5**

TEMPERATURE CONTROLS ARE PRESET IN THE FACTORY FOR RECOMMENDED SETTINGS.

- 5**
- APPLIANCE POLISH WAX IS RECOMMENDED FOR REMOVING TAPE RESIDUE AND HAND PRINTS FROM REFRIGERATOR EXTERIOR.
 - REMOVE ALL TAPE AND OTHER PACKAGING MATERIAL FROM REFRIGERATOR INTERIOR. DO NOT REMOVE SERIAL PLATE.
 - REMOVE PROTECTIVE FILM ON TEMPERATURE CONTROL PANEL.

NOTICE

Removing Doors

Doors should be in closed position. Near lower hinge on freezer side, squeeze collar on water line and pull tubing from coupling. Also, disconnect wiring harness. Pull water line and harness through lower rail.

Remove top hinge covers to access hinges. Remove hinges using a Torx T-20.

Carefully rotate door through 90°. Guiding water line and wiring harness, lift door straight up. Avoid side loading the bottom hinges. Place doors on a protective surface. Avoid pinching the water tube and wire harness at the bottom of the door.

Re-installing Doors

With Doors 90° open, place doors on bottom hinge. Carefully rotate doors to closed position. Avoid side loading the bottom hinges.

Reinstall top hinges and tighten screws firmly. Reinstall hinge cover. If doors are not level, adjust bottom right hinges with a 3/16" open ended wrench.

Insert water tubing back into coupling. It is completely connected when the mark on the tubing is no longer visible. Reconnect wire harness. Turn on water supply.

CAUTION: Do NOT allow the connector to contact the floor. Hard contact can damage the connector.



PREFERRED METHOD

MAKE SURE PROPER GROUND EXISTS BEFORE USE

TEMPORARY METHOD (Adapter plugs not permitted in Canada)

ENSURE PROPER GROUND AND FIRM CONNECTION BEFORE USE

IMPORTANT: PLEASE READ CAREFULLY FOR PERSONAL SAFETY, THIS APPLIANCE MUST BE PROPERLY GROUND.

The power cord of this appliance is equipped with a three-prong (grounding) plug that mates with a standard three-prong (grounding) wall receptacle to minimize the risk of electric shock hazard from this appliance. The customer should have the wall receptacle and circuit checked by a qualified electrician to make sure the receptacle is properly grounded.

Where a standard two-prong wall receptacle is encountered, it is the personal responsibility and obligation of the customer to have it replaced with a properly grounded three-prong wall receptacle.

DO NOT, UNDER ANY CIRCUMSTANCES, CUT OR REMOVE THE THIRD (GROUND) PRONG FROM THE POWER CORD.

USAGE SITUATIONS WHERE THE APPLIANCE'S POWER CORD WILL BE DISCONNECTED INFREQUENTLY
Because of potential safety hazards under certain conditions, we strongly recommend against the use of an adapter plug. However, if you still elect to use an adapter, where local codes permit, a TEMPORARY CONNECTION may be made to a properly grounded two-prong wall receptacle by the use of a UL listed adapter which is available at most hardware stores. The larger slot of the adapter must be aligned to provide proper polarity in the connection of the power cord.

CAUTION: Attaching the adapter ground terminal to the wall receptacle cover screw does not ground the appliance unless the cover screw is metal, and not insulated, and the wall receptacle is grounded through the house wiring. The customer should have the circuit checked by a qualified electrician to make sure the receptacle is properly grounded. When disconnecting the power cord from the adapter, always hold the adapter with one hand. If this is not done, the adapter ground terminal is very likely to break with repeated use. Should this happen, DO NOT USE the appliance until a proper ground has again been established.

USAGE SITUATIONS WHERE THE APPLIANCE'S POWER CORD WILL BE DISCONNECTED FREQUENTLY
Do not use an adapter plug in these situations because frequent disconnecting of the power cord places undue strain on the adapter and leads to eventual failure of the adapter ground terminal. The customer should have the two-prong wall receptacle replaced with a three-prong (grounding) receptacle by a qualified electrician before using the appliance.

Specifications

DISCONNECT POWER CORD BEFORE SERVICING IMPORTANT-RECONNECT ALL GROUNDING DEVICES

All parts of this appliance capable of conducting electrical current are grounded. If grounding wires, screws, straps, clips, nuts or washers used to complete a path to ground are removed for service, they must be returned to their original position and properly fastened.

IMPORTANT SAFETY NOTICE

This information is intended for use by individuals possessing adequate backgrounds of electrical, electronic and mechanical experience. Any attempt to repair a major appliance may result in personal injury and property damage. The manufacturer or seller cannot be responsible for the interpretation of this information, nor can it assume any liability in connection with its use.

ELECTRICAL SPECIFICATIONS

Temperature Control (Position 5)	7-(-11)°F
Defrost Control	60hrs @ 35 min w/ no door openings
Overtemperature Thermostat	140-110°F
Defrost Thermistor	65°F
Electrical Rating: 115V. AC 60 Hz	11.6 Amp
Maximum Current Leakage	0.50 mA.
Maximum Ground Path Resistance	0.14 Ohms
Energy Consumption	KWH/mo.

NO LOAD PERFORMANCE

Control Position MID/MID and Ambient of:	70°F	90°F
Fresh Food, °F	34-40	34-40
Frozen Food, °F	(-3) 3	(-3) 3
Run Time, %	<45%	<70%

REFRIGERATION SYSTEM

Refrigerant Charge (R134a)	4.75 ounces
Compressor	690 BTU/hr
Minimum Compressor Capacity	22 inches
Minimum Equalized Pressure	
@ 70°F	48 PSIG
@ 90°F	60 PSIG

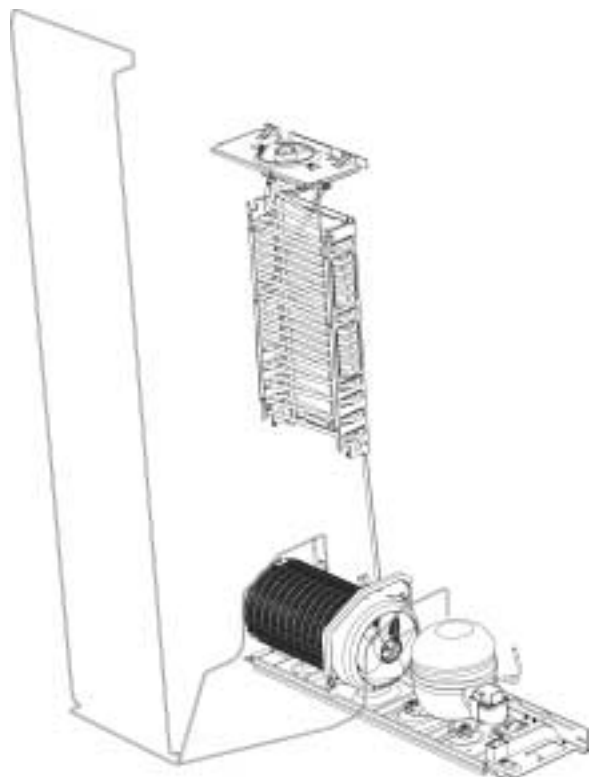

INSTALLATION

Clearance must be provided for air circulation	
AT TOP	1"
AT SIDES	1/8"
AT REAR	1"

AIR FLOW

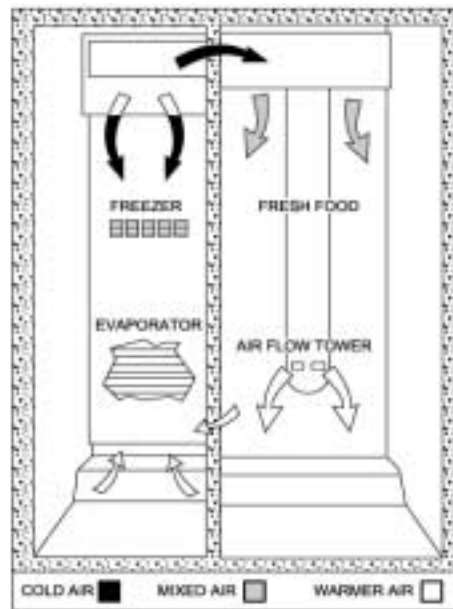
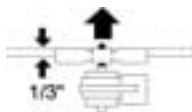

MODELS

PSC21MGM	PSI21MGM
PSC23MGM	PSI23MGM

REPLACEMENT PARTS

Temperature Control	wr55x10023
Relay	wr07x10031
Overload	wr08x10025
Run Capacitor (12 µF)	wr62x10079
Overtemperature Thermostat	wr50x10015
Defrost Heater Harness & Thermostat	wr23x10142
Defrost Heater & Bracket	wr51x10030
Condenser Fan Motor	wr60x10042
Evaporator Fan Motor	wr60x10043
Main Board	wr55x10024
Dispenser Board	wr55x10029
Thermistor (EV)	wr55x10025
Thermistor (FZ)	wr55x10026
Thermistor (FF)	wr55x10027
Thermistor (FF)	wr55x10028
FF Fan Motor	wr60x10051
Damper	wr60x10052

Nomenclature

Profile 2001 Models

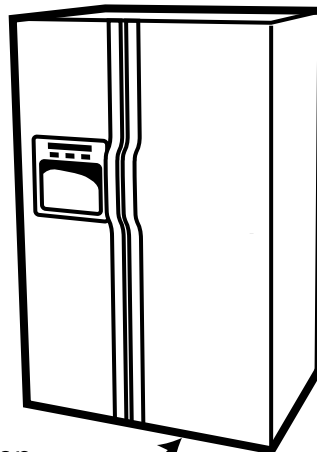
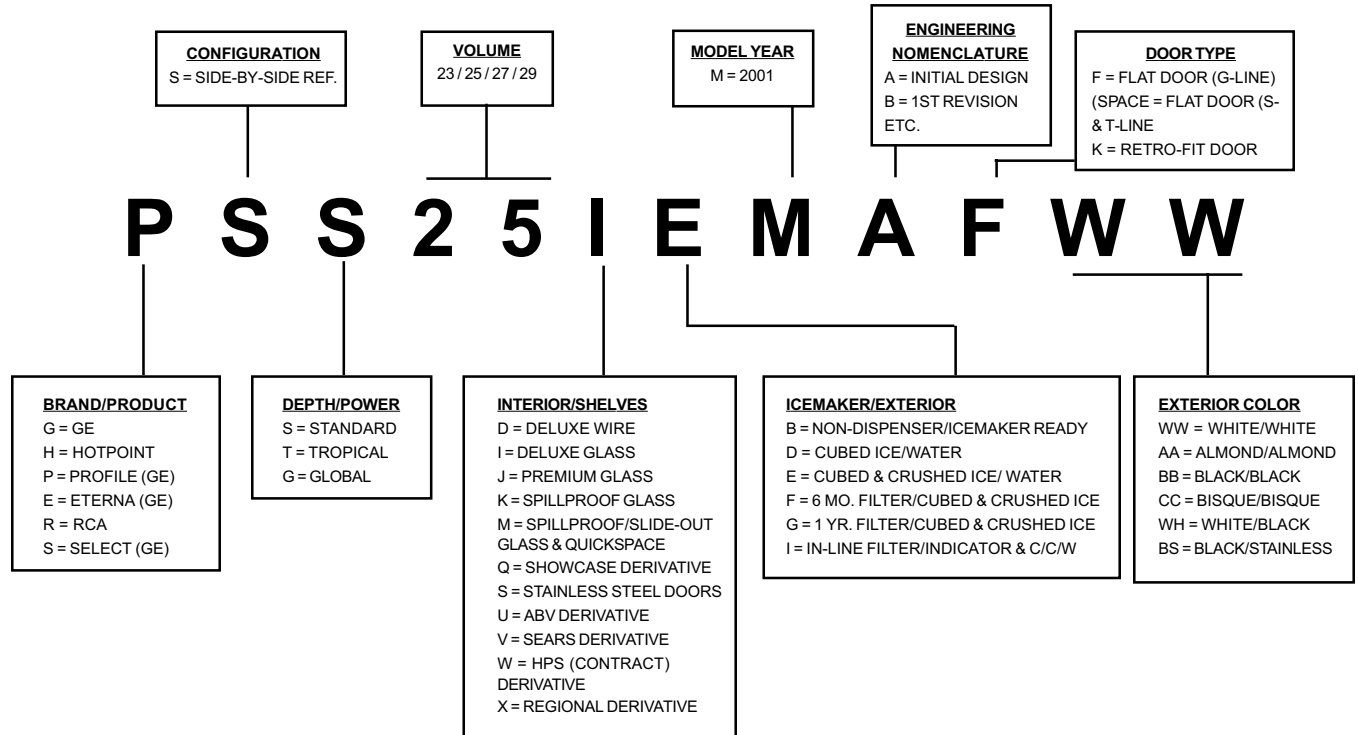

Location
Tech Data
Sheet

(Remove base grille asm. Taped under cabinet)

Warranty Information

Sales slip or cancelled check is required as proof of original purchase date to obtain service under warranty.

All warranty service is provided by our Factory Service Centers or an authorized Customer Care® technician.

For The Period Of:	GE Will Replace:
One Year From the date of the original purchase	Any part of the refrigerator (excluding water filter cartridge) which fails due to a defect in materials or workmanship. During this full one-year warranty , GE will also provide, free of charge , all labor and in-home service to replace the defective part.
Five Years From the date of the original purchase	Any part of the sealed refrigerating system (the compressor, condenser, evaporator, and all connecting tubing) which fails due to a defect in materials or workmanship. During this five-year warranty , GE will also provide, free of charge , all labor and in-home service to replace the defective part.
Lifetime From the date of the original purchase	Any see-through pan or drawer furnished with the refrigerator if the pan or drawer breaks during normal household use. Drawer covers are not included.
Thirty Days From the date of the original purchase	Any part of the water filter cartridge which fails due to a defect in materials or workmanship. During this full thirty-day warranty , we will also provide, free of charge , all labor and in-home service to replace the defective part.

What GE Will Not Cover:

- Service trips to your home to teach you how to use the product.
- Improper installation.
- Failure of the product if it is abused or used for other than the intended purpose or used commercially.
- Loss of food due to spoilage.
- Replacement of house fuses or resetting of circuit breakers.
- Replacement of the water filter cartridge due to water pressure that is outside the specified operating range or due to excessive sediment in the water supply.
- Replacement of water filter cartridge after its expected useful life, 30 days.
- Damage to the product caused by accident, fire, floods, or acts of God.
- Incidental or consequential damage caused by possible defects with this appliance.

This warranty is extended to the original purchaser and any succeeding owner for products purchased for home use within the USA. In Alaska, the warranty excludes the cost of shipping or service calls to your home.

Some states do not allow the exclusion or limitation of incidental or consequential damages. This warranty gives you specific legal rights, and you may also have other rights which vary from state to state. To know what your legal rights are, consult your local or state consumer affairs office or your state's Attorney General.

Warrantor: General Electric Company. Louisville, KY 40225

Operating Characteristics

Table of Contents

Fresh Food/Freezer Independent Operation	8
Normal Operating Characteristics, but Different from Previous Models	8
Abnormal Operating Characteristics (Incorrect Operation)	8
Adaptive Defrost	8
Cooling Operation (Adaptive Defrost)	9
Pre-Chill Operation (Adaptive Defrost)	9
Defrost Heater Operation (Adaptive Defrost)	9
Dwell Period (Adaptive Defrost)	9
Post Dwell (Adaptive Defrost)	9
Liner Protection Mode	9
Electronic Icemaker	10
Dispensing Functions	10
Quick Ice	10
Door Alarm	10
Dispenser Light	10
Dispenser Lock	10
Filters	11
Hinge System and Door Closure	11
Airflow (Cabinet Interior)	11
“Jelly Roll” Condenser	12
Main Control Board	13

Fresh Food/Freezer Independent Operation

In previous models, the fresh food and freezer compartment components worked at the same time. When the fresh food compartment called for cold air, the freezer compartment components would work with the fresh food compartment components. This is called nonindependent operation.

In this model, the fresh food compartment components can operate without the freezer compartment components operating. This is called independent operation.

Normal Operating Characteristics that May Occur, but Different from Previous Models

- Icemaker auger rotates clockwise.
- Evaporator fan running, without compressor or condenser fan. Fresh food fan is on.
- Post dwell (adaptive defrost), compressor and condenser fan on with evaporator fan off after defrost cycle.
- Liner Protection Mode, fans come on when the doors are open for 3 minutes.
- When the doors open, the fans shut off.
- No airflow to the fresh food compartment when the evaporator fan is on.
- Evaporator fan and compressor can run continuously for 8 hours.
- Fans shift speeds, different sound levels can be noticed when this happens.
- Quick Ice mode, the evaporator fan runs for 48 hours non-stop.
- Response time for drastic temperature change is 2 to 10 minutes. The main control board will only respond to 8 degrees of temperature change per minute as determined by resistance change of sensor.

Abnormal Operating Characteristics (Incorrect Operation)

- Fresh food fan on and evaporator fan off.
- Evaporator fan on, fresh food fan and compressor off, and damper shut.
- Rapid fan speed changes, fan takes at least 1 minute to change speeds.
- Compressor running without the condenser fan. The compressor and condenser fan should always run at the same time.
- Condenser fan running without the compressor. The compressor and condenser fan should always run at the same time.

Adaptive Defrost

Adaptive defrost can be described as a defrost system that adapts to a refrigerator's surrounding environment and household usage.

Unlike conventional defrost systems that use electromechanical timers with a fixed defrost cycle time, adaptive defrost utilizes an intelligent, electronic control to determine when the defrost cycle is necessary. In order to accomplish the correct defrost cycle time, the main control board monitors the following refrigerator operations:

- Length of time the refrigerator doors were open since the last defrost cycle.
- Length of time the compressor has run since the last defrost cycle.
- Amount of time the defrost heaters were on in the last defrost.

Adaptive defrost is divided into 5 separate cycles. Those operations are:

- Cooling Operation
- Pre-Chill Operation
- Defrost Heater Operation
- Dwell Period
- Post dwell

Refer to Pub # 31-9062 for more information about Adaptive Defrost.

Cooling Operation (Adaptive Defrost)

During the cooling operation, the main control board monitors door opening (fresh food and freezer doors) and compressor run times. The length of time between consecutive defrosts is reduced by each door opening. If the doors are not opened, the compressor will run up to 60 hours between defrosts. If the doors are opened frequently and/or for long periods of time, the compressor run time between defrosts will be reduced to as little as 8 hours.

Pre-Chill Operation (Adaptive Defrost)

When the main control board determines that defrost is necessary, the main control board will force the refrigerator into a continuous cool mode (pre-chill). During pre-chill, the freezer temperature may be driven below the temperature control panel display setpoint. However, the fresh food temperature will be regulated by the damper. Pre-chill will last for 2 hours if it is not interrupted by any door openings. If, after 8 hours, the unit has been unable to complete an uninterrupted pre-chill, it will proceed to the defrost cycle.

Defrost Heater Operation (Adaptive Defrost)

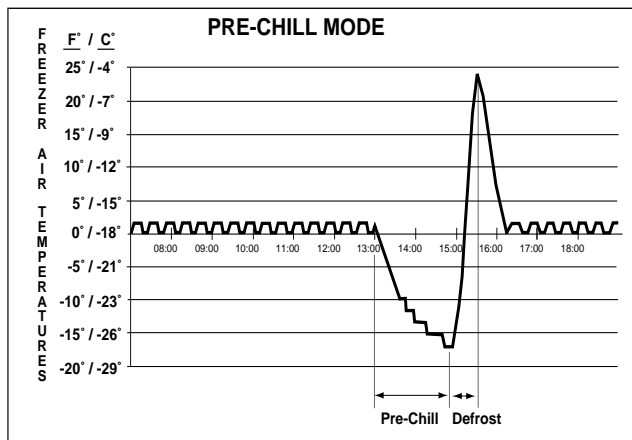

After 2 hours of pre-chill operation or 8 hours of interrupted pre-chill attempts, the main control board turns the compressor, condenser fan, and evaporator fan off. The main control board then energizes the defrost relay, which completes the defrost circuit.

During defrost operation, the main control board monitors the evaporator temperature using evaporator thermistor inputs. The thermistor will terminate defrost heater operation usually in less

than 20 minutes. Typical defrost time is 20-30 minutes.

The defrost system is protected by a defrost thermostat (switch). The thermostat opens when the evaporator temperature raises to 140° Fahrenheit and closes when the evaporator temperature lowers to 110 degrees Fahrenheit.

Dwell Period (Adaptive Defrost)

After defrost heater operation has been terminated by the main control board, a 5-minute dwell period occurs. During this period, the compressor, the condenser fan, and the evaporator fan remain off. The remaining frost melting from the evaporator will continue to drip and drain so the evaporator will be totally clear of any moisture prior to the cooling operation. After the 5 minute dwell period, the unit goes into post dwell.

Post Dwell (Adaptive Defrost)

The post dwell period is designed to cool the evaporator before circulating air within the refrigerator. This prevents any residual heat on the evaporator from being distributed in the freezer. During this period, the compressor and condenser fan are on, but all interior fans are off and the damper is closed. Post dwell times vary with different models. However, there is a 5-minute maximum post dwell time.

Liner Protection Mode

The liner protection mode will activate if either of the doors have been open for 3 minutes. This mode will start the fans and close the damper.

This mode is controlled by 2 timers. Timer #1 monitors door-open time. A 3-minute door-open count begins when the door is opened. If 3 minutes elapse before the door is closed, the liner protection mode will become active. Once the door is closed, timer #1 resets and liner protection mode goes into standby.

In standby, normal fan and damper operations resume and timer #2 begins a 3-minute door-closed count. If 3 minutes elapse without a door opening, liner protection mode will completely deactivate. If a door is opened within the timer #2 door-closed count, the remaining time in the door-closed count will be deducted from the timer #1 door-open count.

Electronic Icemaker

This refrigerator is equipped with an Electronic Icemaker. Refer to Pub # 31-9063 for more information.

Dispensing Functions

The water, crushed ice, and cubed ice functions are controlled by the main control board. To select a function, press the appropriate pad on the dispenser. The LED will light to identify the selection.

To dispense the selected item, depress the dispenser cradle located in the dispenser recess. The solenoid and linkage assembly will open the ice chute door to dispense the ice. If cubed ice is selected, the crushed ice bypass solenoid will allow cubed ice to bypass the ice crusher. The ice chute door must remain open for 5 seconds after dispensing ceases. After this 5-second delay, the solenoid and linkage assembly will shut the ice chute door.

The dispenser light will come on automatically when the dispenser cradle is depressed and will fade out 5 seconds after it is released.

The dispenser selection is recorded in the main control board. In the event of a power failure, the last selected function will be restored.

Quick Ice

The quick ice feature is available on some models. This feature causes the evaporator fan to operate non-stop for 48 hours (fan may operate in high or low speed). This enables maximum icemaker output.

The QUICK ICE pad initiates the quick ice mode in the refrigerator. Pressing the QUICK ICE pad lights the LED and sets the evaporator fan to run at medium speed (unless the main control board selects high speed) for a 48-hour period. The evaporator fan is terminated during defrost, dwell, post dwell, and door openings.

The quick ice selection is stored in the main control board. The function will be restored in the event of a power failure.

Door Alarm

The DOOR ALARM pad is used to turn on and turn off the door alarm feature. If the feature is on, the DOOR ALARM LED will flash when the door is opened. If the door is open for more than 2 minutes, the door alarm will sound. The alarm can be stopped by pressing the DOOR ALARM pad or by shutting the door. If the DOOR ALARM pad is pushed while the door is open, the alarm will stop but the led will continue to flash until the door is closed. When the door is closed it will reset the audible alarm. This feature will be retained in the event of a power failure.

Dispenser Light

The LIGHT pad turns the dispenser light on and off. When the light is turned off, it will fade out. The dispenser light will come on automatically when the dispenser cradle is depressed and will fade out 5 seconds after it is released. The LIGHT pad will not turn off the light during dispense.

Dispenser Lock

When the dispenser system is locked, no dispenser command will be accepted. This includes the dispenser cradle and will prevent accidental dispensing that may be caused by children or pets. If a pad is pressed with the system locked, it will be acknowledged with 3 pulses of the LOCK LED accompanied by an audible tone.

To lock or unlock communication between the dispenser and the main control board, press the LOCK pad and hold it for 3 seconds. The LOCK LED will flash while the LOCK pad is pressed. When the communication is locked, the LOCK LED will be illuminated.

The status of other functions, selected prior to the initiation of the lock feature, will be displayed. If the lock is engaged while a mode is active, the LED will remain on until that mode times out.

If the lock is engaged when the filter timer expires, the LED will come on but cannot be reset until the lock is turned off.

The lock feature will be retained through a power outage.

Filters

The FreshSaver filter is located on the FRESH PRODUCE drawer and will last for 1 year. Some models are equipped with a FreshSaver FILTER LED. After 1 year of refrigerator operating time, the FreshSaver FILTER LED will illuminate as a reminder to the owner to change the filter. The LED can be reset by pressing and holding the HOLD 3 SECS pad for 3 seconds. The LED will flash while the pad is pressed, remain illuminated for 3 seconds after the pad is released, and turn off.

Some models are equipped with a water filter that is located in the upper right-hand corner of the fresh food compartment. Filters are designed to be used for up to 18 hours of open valve time or 1 year of clock time.

When 90% of filter time has elapsed (open valve time or clock time, whichever comes first), the main control board will illuminate the filter reminder LED (amber). When 100% of the filter time has elapsed, the main control board will illuminate the filter reminder LED (red).

Hinge System and Door Closure

The hinge brackets are not adjustable on the cabinet. The fresh food door can be adjusted up and down by using the hinge adjustment pin (located on the fresh food lower door hinge).

This refrigerator is equipped with a door opening/closing feature. This feature consists of a spring-loaded arm located at the bottom of the cabinet for each door. The arm provides a stop for the door when the door is partially open and automatically closes the door when the door is almost closed.

IMPORTANT: The refrigerator rollers must be adjusted correctly for proper door closure. When the rollers are adjusted correctly, the door should close easily when open approximately 45 degrees (halfway).

Airflow (Cabinet Interior)

AIR FLOW

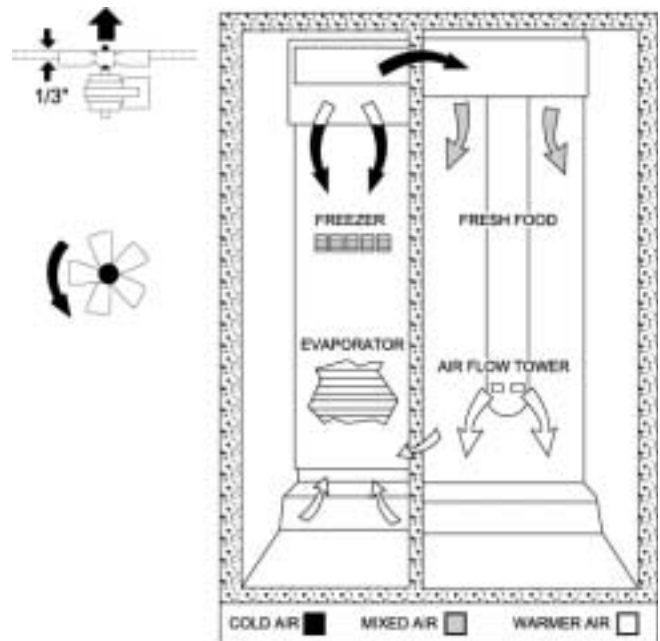

The freezer cabinet is designed so that air is drawn into the bottom of the air tunnel and through the evaporator when the evaporator fan is operating. The chilled air is then pushed out into the top of the freezer.

The fresh food compartment receives chilled air via an electronic damper that is positioned at the top rear of the refrigerator between the freezer cabinet and the fresh food cabinet. The damper is controlled by the main control board and when open, allows chilled air from the freezer air tunnel to move into the fresh food air tower. The fresh food air tower contains a fresh food fan which draws chilled air from the freezer (through the damper) into the air tower. The air tower directs chilled air across the top of the fresh food cabinet to two outlets. The air tower also directs chilled air down the back wall of the fresh food cabinet. The chilled air exits the air tower through vents in the tower.

Air returns from the fresh food cabinet to the freezer cabinet via a mullion located to the left of the FRESH PRODUCE drawer.

“Jelly Roll” Condenser

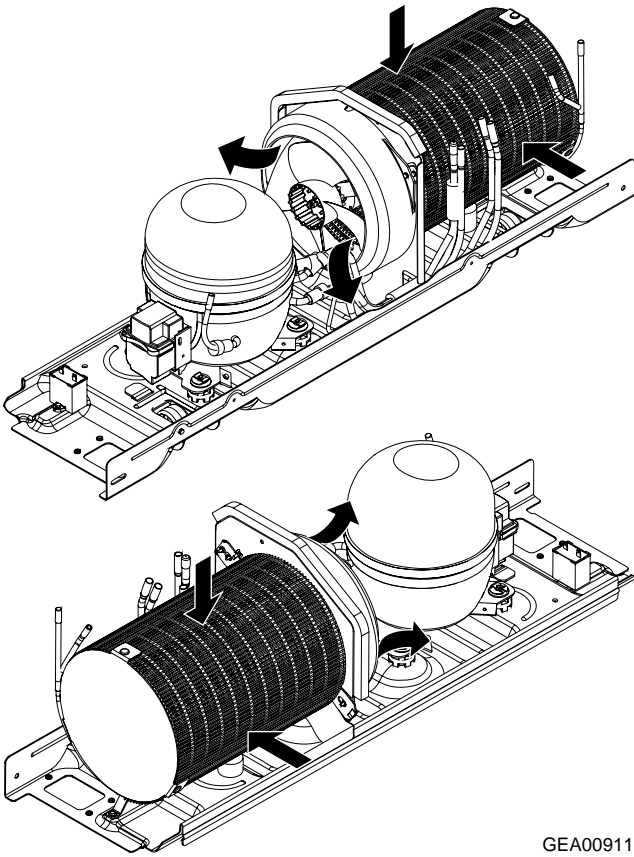

GEA00911

The “jelly roll” condenser is a new type of condenser. The condenser fan is located at one end of the “jelly roll” condenser and a solid plate is located at the other end. Air is drawn in through the outside diameter of the condenser and pulled out by the condenser fan. The condenser is located in the machine compartment which can be accessed from the back of the unit at the bottom.

Main Control Board

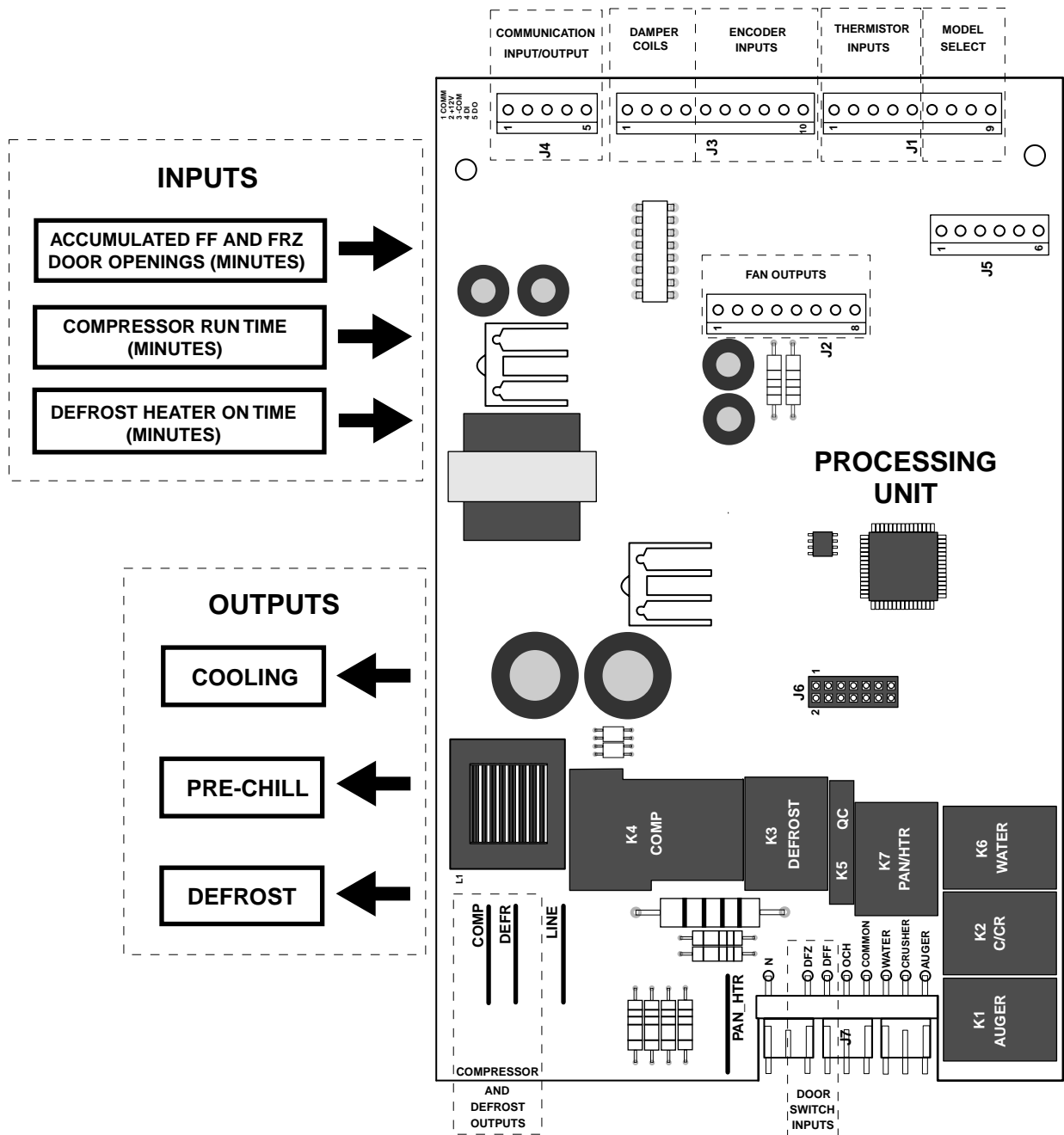

General Locator Views

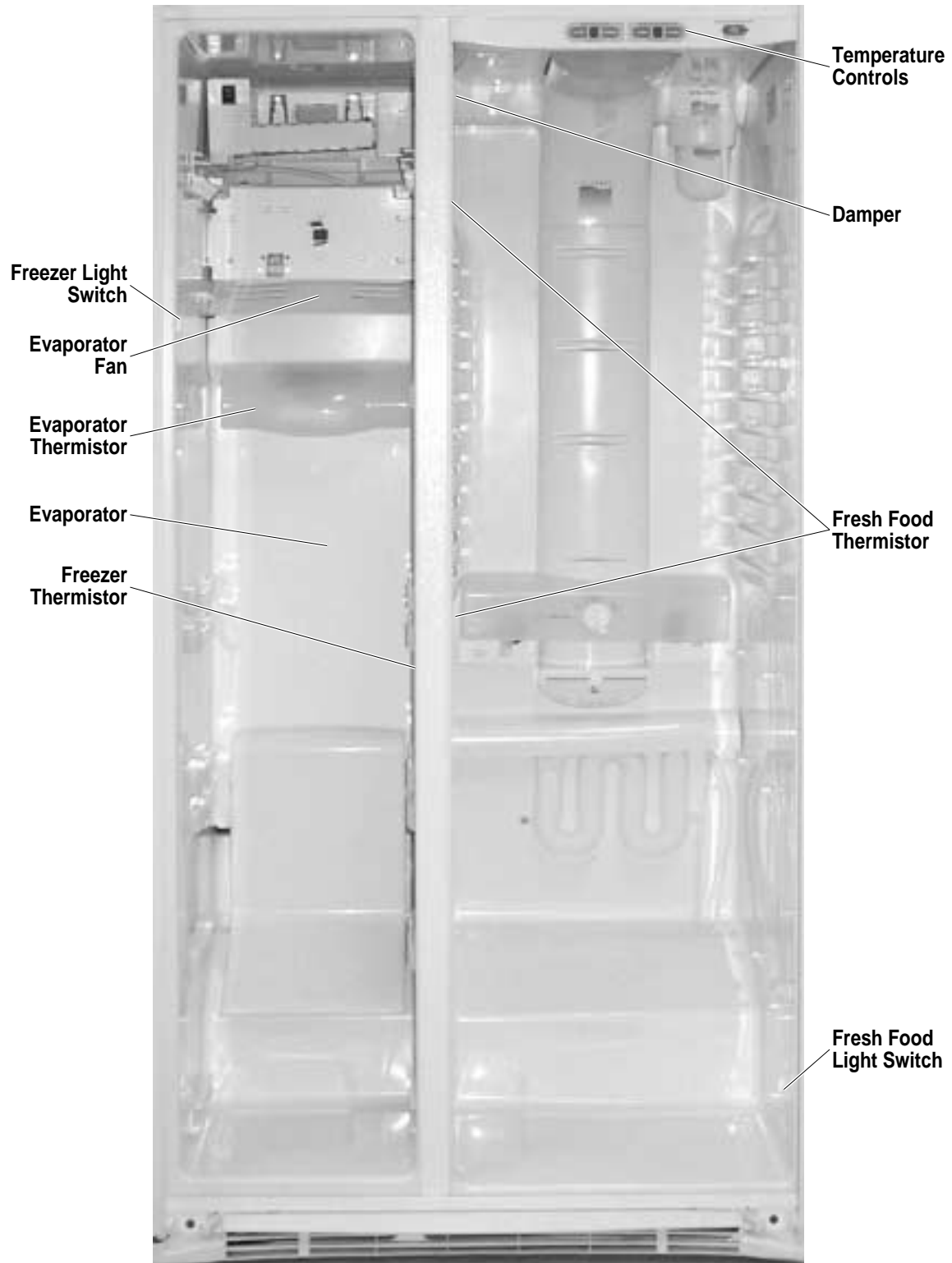

GEA00979

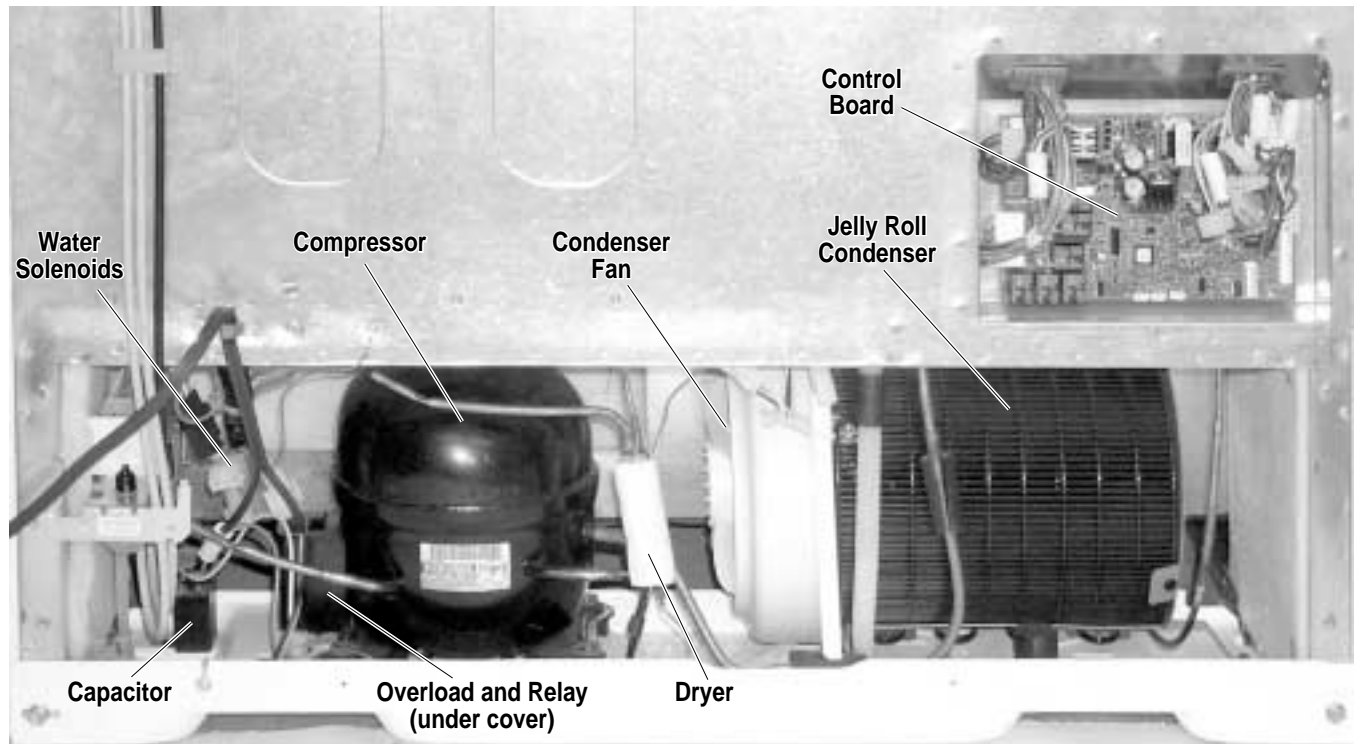

GEA00977

Mechanical Disassembly

Table of Contents

Door Handle.....	18
Door Gasket.....	18
Fresh Food Compartment Quick Access Door	18
Fresh Food Door Light Switch	19
Fresh Food Compartment Door Shelves	19
Fresh Food Compartment Shelves	19
Fresh Food Compartment Drawers.....	19
Fresh Food Compartment Lights	19
Water Filter.....	20
Fresh Food Fan and Mullion Damper	20
Deli Fresh Damper	21
Fresh Food Thermistors	21
Temperature Control Panel	22
Freezer Door Bins.....	22
Doors and Door Hinges	22
Fresh Food Door Adjustment	23
Rollers	23
Roller Adjustment.....	24
Freezer Compartment Shelves and Bins	24
Freezer Door Light Switch	24
Ice Dispenser.....	24
Ice Dispenser Auger Drive and Cube Solenoid	25
Icemaker.....	25

Freezer Light	26
Evaporator Fan	26
Evaporator Thermistor	27
Defrost Thermostat	27
Defrost Heater	27
Evaporator Drip Pan	28
Evaporator	28
Freezer Thermistor	28
Condenser Fan	29
Main Processor Card	29
Water Solenoids	29

Door Handle

The door handles allow access into the fresh food and freezer compartments. They are front mounted with 1 Torx head screw.

1. With a small flat-blade screwdriver, slide the handle trim down and pull it out.
2. Remove the lower Torx head screw.
3. Lift the handle in and upward motion until it disengages the locking tabs. Pull the handle outward to remove it.



Door Gasket

The door gasket is a molded gasket set into a channel located in the door liner.

1. Open the door.
2. Grasp the gasket and pull in an outward motion until the molded gasket separates from the door liner.



Fresh Food Compartment Quick Access Door

The fresh food compartment allows access to the fresh food compartment without opening the fresh food door.

1. Open the quick access door and remove the hinge Torx head screws (2), located on each side of the door.



2. With a small flat-blade screwdriver, remove the door frame and door frame assembly.
3. Remove the gasket and slide the door out of the frame.
4. The quick access door also has an interlock switch located at the top right-hand side of the interior frame. Remove the Phillips screw and slide the switch assembly down and out.
5. Disconnect the wires to the switch and remove it.



Fresh Food Door Light Switch

In addition to the quick access door light switch, the fresh food compartment has a door light switch located in the lower right corner for the compartment.

1. Use a small flat-blade screwdriver to unlock the locking tab tabs and pull the switch out until the wire connector is visible.
2. Disconnect the connector and remove the switch.



Fresh Food Compartment Door Shelves

The door shelves allow storage of perishable items.

1. Tilt the shelf up and slide it out.



Fresh Food Compartment Shelves

These shelves allow the storage of larger items and pull out for easy access.

1. Pull the shelf out until the shelf stop tab meets the compartment stop.
2. Push the shelf stop tab down and pull the shelf out until it is removed.

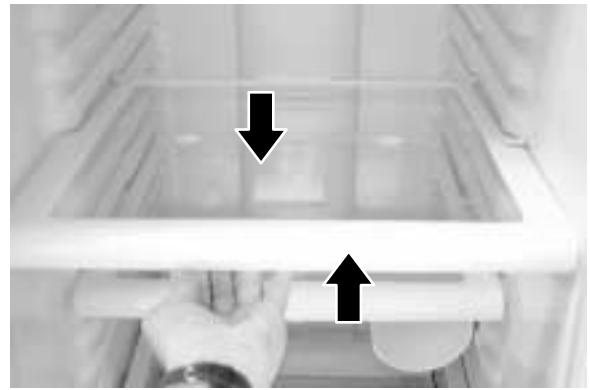

Fresh Food Compartment Drawers

Fresh food compartment drawers are designed for storage of fruits, vegetables, and deli items. The drawers are located in the lower portion of the fresh food compartment.

1. Pull out the drawer until the rollers meet the mechanical stop.
2. Tilt the drawer up and pull it out until it is removed.

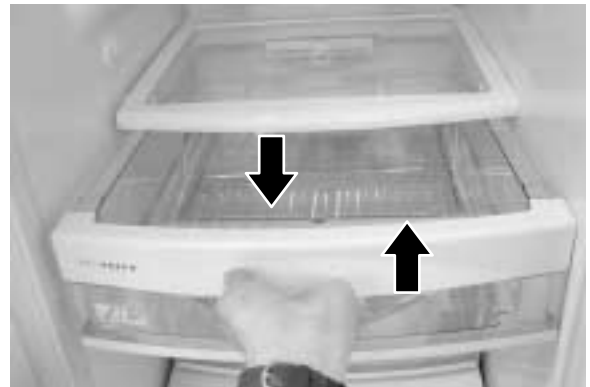

Fresh Food Compartment Lights

The fresh food compartment lights are located in the upper and lower portion of the fresh food compartment.

1. To access the upper lights, remove the upper opaque cover by unlocking the tabs and pulling the cover down.



GEA00930

2. To access the lower lights, pull the deli fresh damper adjusting knob off.
3. Lift the opaque cover off the tabs.

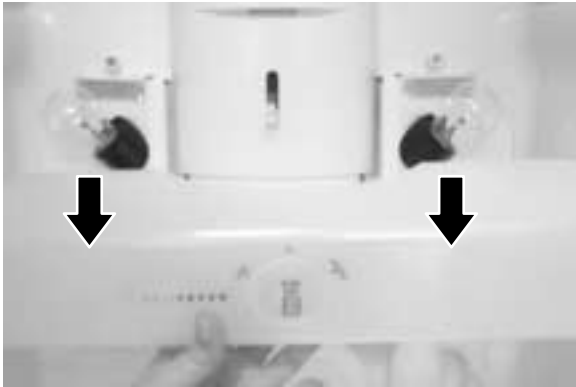

GEA00931

Water Filter

The water filter is located in the upper right-hand portion of the fresh food compartment. The water filter, filters water for the ice maker and the water dispenser. An LED on the temperature control panel will illuminate when the filter needs to be changed.

1. Turn the water filter 1/2 turn counterclockwise and pull it down.
2. To install the filter, push it up while turning 1/2 turn clockwise. Do not force the filter.



GEA00933

Fresh Food Fan and Mullion Damper

The fresh food compartment fan is located under the upper ductwork in the fresh food compartment. This fan distributes cold air from the freezer via the mullion damper. The mullion damper is located in the same assembly as the fan. Both are controlled by the processor.

1. Remove the deli fresh adjusting knob and light cover.
2. Unlock the upper and lower locking tabs for the center ductwork and remove. The ductwork is also fastened with double-sided tape at the upper and lower portions.



GEA00932

3. Remove the upper water filter cover.
4. Unlock the upper opaque light cover tabs and remove the cover.
5. Unlock the upper ductwork tabs and remove it.



GEA00934

6. Remove the Phillips head screws (8) for the upper light assembly plastic bracket.

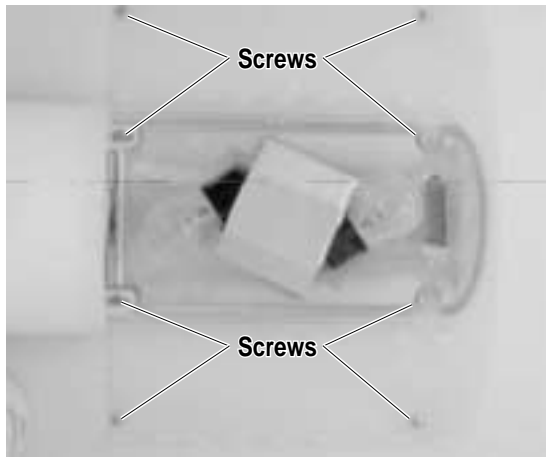

GEA00935

7. Pull the stainless steel light bracket down until the wires are exposed and disconnect them.
8. Remove the Phillips head screws (2) for the fresh food fan and damper cover and remove the cover.

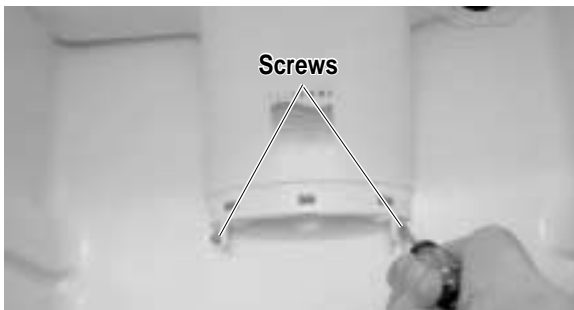

GEA00936

9. Lay the fan and damper assembly against the compartment and open the back cover.
10. Disconnect the wire connections and remove the damper or fan.



GEA00937

Deli Fresh Damper

The deli fresh damper is located at the bottom of the cold air ductwork. It allows the flow of cold air to be adjusted to the deli fresh drawer.

1. Remove the deli fresh damper adjusting knob and the lower light cover.
2. Remove the center ductwork by unlocking upper and lower tabs. Double-sided tape is applied to upper and lower areas.
3. Remove the damper Phillips head mounting screws (3) and remove the damper.

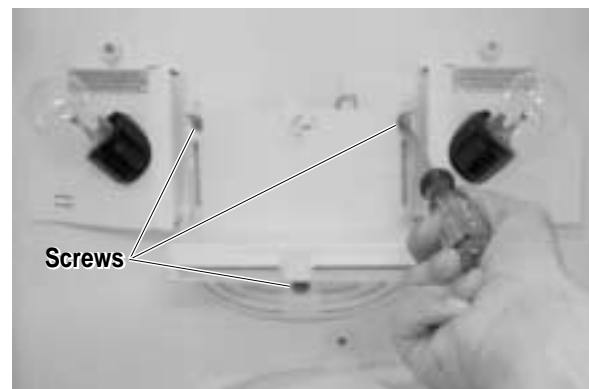

GEA00938

Fresh Food Thermistors

The fresh food thermistors are located at the upper and lower portions of the fresh food compartment. They send temperature signals to the processor.

1. With a small flat-blade screwdriver, unlock the tabs and remove the assembly.
2. Remove the thermistor from the cover and disconnect the wire connector.



GEA00939

Temperature Control Panel

The temperature control panel is located in the fresh food compartment and mounted at the upper front. This panel allows temperature control for the fresh food and freezer compartments. Each compartment has an LED readout of the temperature setting. In addition the panel has an LED readout for water filter change.

1. Remove the control panel Phillips head mounting screws (3).
2. Pull the panel down until the wire connections are exposed.

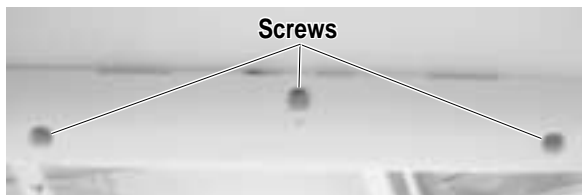

GEA00940

4. Disconnect the panel wire connector.
5. Disconnect the circuit card ribbon.
6. Unlock the card locking tabs located at the lower left- and right-hand corners of the card.
7. Remove the card.



GEA00941

Freezer Door Bins

The freezer door bins are located on the inside of the freezer door and tilt out to allow easy access of frozen items.

1. Tilt the bin up and slide it out of the door.



GEA00942

Doors and Door Hinges

IMPORTANT: The freezer door is not adjustable. The fresh food door can be adjusted up and down to match the height of the freezer door. Adjust the fresh food door up or down using the hinge adjustment pin (located on the fresh food door lower hinge).

IMPORTANT: The refrigerator rollers must be adjusted correctly to ensure proper door closure. Refer to the Roller Adjustment section in this chapter for more information.

1. Remove the base grille.
2. With the door in the closed position, disconnect the wiring harness connector.
3. Disconnect the water supply tube. To disconnect the tube, push the white collar on the quick connector in and pull the tube out.

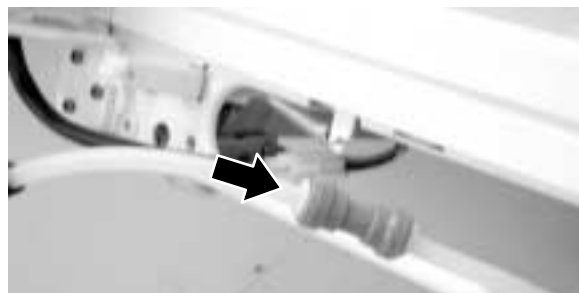

GEA00943

4. With a small flat-blade screwdriver, disengage the locking tabs of the upper hinge cover and remove it.
5. Remove the Torx head hinge screws (2) and lift the upper hinge off the unit.



CAUTION: Do not side-load hinges.

CAUTION: Freezer door only — Do not allow the connector to contact the floor. Hard contact may damage the connector.

NOTE: Guide the waterline and wiring harness through hinge while lifting the door from hinge.

6. Open the door 90° and lift door straight up and off the lower hinge.

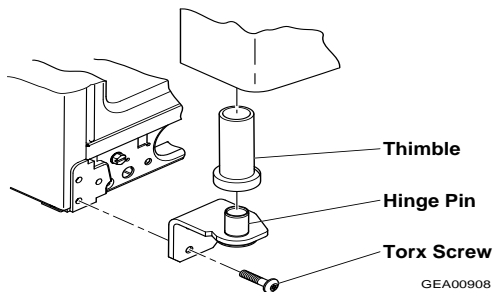

Lower Hinge, Freezer Side

7. Remove the Torx screws (3) and the lower hinge from the cabinet.

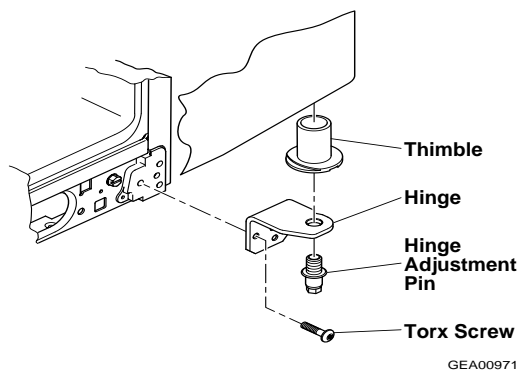

Lower Hinge, Fresh Food Side

Fresh Food Door Adjustment

IMPORTANT: The freezer door is not adjustable. The fresh food door can be adjusted to match the height of the freezer door.

IMPORTANT: The refrigerator rollers must be adjusted correctly to ensure proper door closure. Refer to the Roller Adjustment section in this chapter for more information.

1. Remove the base grille.
2. Turn the hinge adjustment pin (located on the fresh food lower hinge) clockwise to raise the door level and counterclockwise to lower the door.

Rollers

This unit has 4 rollers for easy movement of the refrigerator. There are 2 rollers located in the front and 2 rollers located in the rear of the unit.

IMPORTANT: The refrigerator rollers must be adjusted properly to ensure proper door closure. Refer to Roller Adjustment.

1. To remove the front rollers, back the level adjusting screw all the way out.
2. Remove the 1/4-in. roller mounting screws and remove the caster.

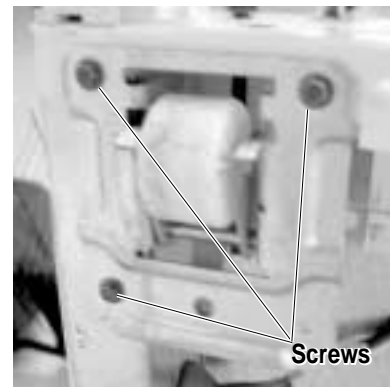

3. To remove the rear rollers, remove 1/4-in. mounting screws (2).
4. Tilt the roller down and slide it out.

Roller Adjustment

The front (2) rollers are adjustable. Adjust them so that the refrigerator is solid and the doors close easily.

1. Remove the base grille.
2. With a flat-blade screwdriver, turn the adjusting screw clockwise to raise the roller and counterclockwise to lower the roller.



GEA00946

Freezer Compartment Shelves and Bins

The shelves and bins slide out for easy access for frozen items.

1. Slide the shelf/bin out until it reaches its stop.
2. Tilt the shelf/bin up and slide it out of the compartment.



GEA00947

Freezer Door Light Switch

This switch is located in the left-hand portion of the freezer compartment and sends a signal to the processor.

1. With a small flat-blade screwdriver, unlock the locking tabs and pull the switch out until the wire connector is visible.
2. Disconnect the wire connector and remove the switch.



GEA00948

Ice Dispenser

The ice dispenser is located in the upper portion of the freezer compartment. This assembly stores ice made by the icemaker and dispenses ice on demand from the door dispenser target switch.

1. Remove the upper ice bucket tray.
2. Slide out the ice dispenser assembly.



GEA00949

3. Remove the ice cube solenoid linkage Phillips head screw and slide the linkage back.
4. Remove the ice crusher cover Phillips head screws (2) and remove the cover.
5. With a pair of pliers, twist off the backing plate tabs located on either side of the crusher.



GEA00950

6. With 2 small flat-blade screwdrivers, unlock the ice crusher locking tabs located at either side of the ice crusher.
7. Lift the ice crusher out of the bucket.

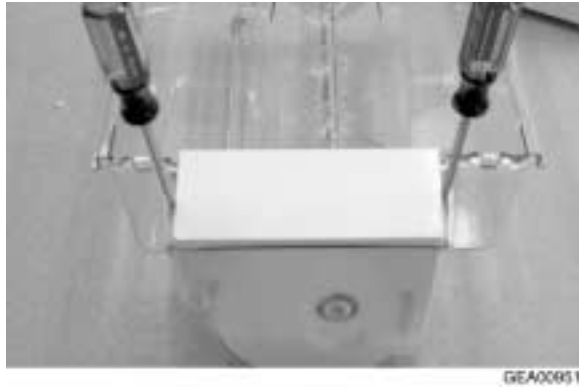

8. Remove the ice crusher back cover.
9. Remove the locking ring from the ice crusher auger.
10. Remove the plastic nut with a pair of pliers by turning it clockwise.
11. Remove the spacers and blades. The blades are numbered for reassembly.

Ice Dispenser Auger Drive and Cube Solenoid

The ice dispenser drive motor and cube solenoid are located in the upper rear of the freezer compartment. The drive motor moves the auger via a fork located on the drive motor. The cube solenoid allows cube or crushed ice to be dispensed on demand.

1. Remove 1/4-in. housing mounting screws (4) located at the four corners of the housing.
2. Slide the housing forward until the connector is visible, disconnect the connector, and remove the unit from the housing.

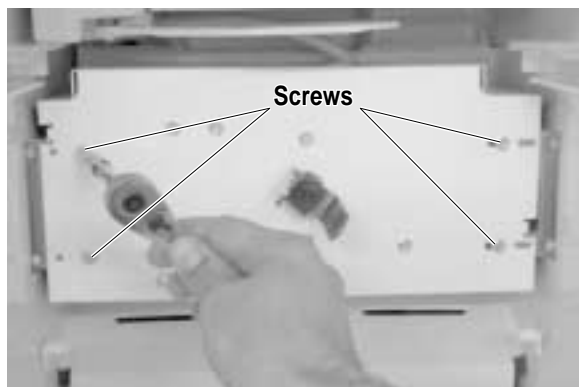

Note: Drive fork has reverse threads; turn clockwise to remove.

3. Remove the fork from the drive motor by turning it clockwise.
4. Disconnect the motor connectors and remove the ground wire.



5. Remove 1/4-in. mounting screws (3) and remove the motor.
6. Disconnect the cube solenoid wires.
7. Remove cube solenoid 1/4-in. mounting screws (2) and remove the cube solenoid.



Icemaker

The icemaker is located in the upper rear of the freezer compartment and supplies ice to the dispenser tub.

1. Disconnect the icemaker cable connector.
2. Remove 1/4-in. icemaker mounting screws and slide out the icemaker.

This refrigerator is equipped with an Electronic Icemaker. Refer to Pub # 31-9063 for more information.

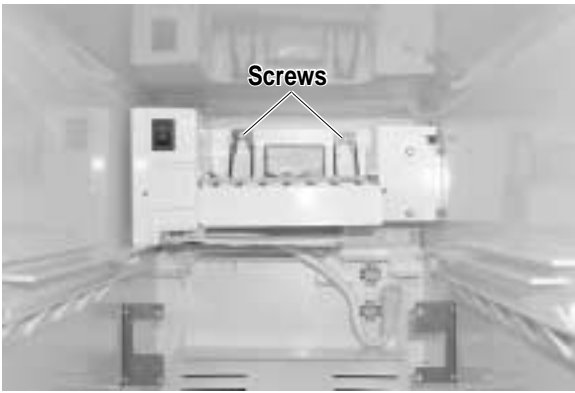

GEA00955

Freezer Light

The freezer light is located in the upper rear of the freezer compartment. The light is covered by an opaque cover.

1. Unlock the locking tabs and remove the cover.
2. Replace the appliance light.



GEA00956

Evaporator Fan

The evaporator fan is located in the upper rear portion of the freezer compartment. This fan supplies cold air to the freezer and fresh food compartments. The evaporator thermistor **must** be replaced when replacing the fan.

1. Remove 1/4-in. icemaker bracket screws (4) located at the four corners of the bracket.

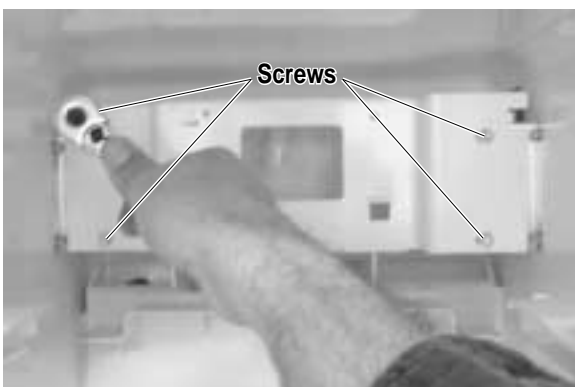

GEA00957

2. Remove 1/4-in. ice dispenser drive mounting bracket screws (2) and remove the brackets.

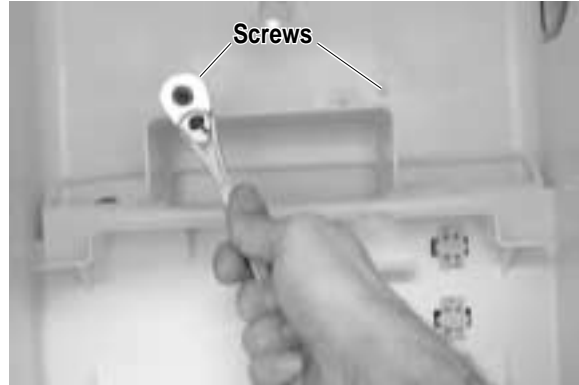

GEA00958

3. Remove 1/4-in. upper evaporator fan ductwork screws (2).
4. Unlock the tabs and remove the lower evaporator fan ductwork.
5. Remove 1/4-in. evaporator cover screws (4) and remove the cover.

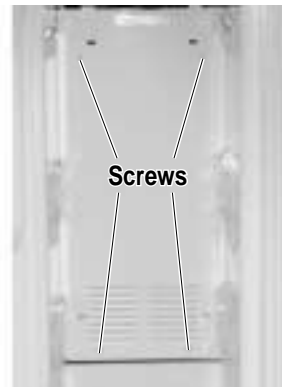

GEA00959

6. Remove 1/4-in. upper evaporator fan duct work screws (2), located at the lower portion of the ductwork.
7. With a small flat-blade screwdriver, unlock the tabs for the icemaker and dispenser cables.
8. Slide the upper fan ductwork out.
9. Disconnect the evaporator fan wiring harness.



10. Remove the 1/4-in. screw for the evaporator fan ground wire.
11. Remove the 1/4-in. evaporator fan bracket mounting screws (2), located at either side of the bracket.
12. Remove the evaporator fan assembly.

Evaporator Thermistor

The evaporator thermistor is snapped on to the top portion of the evaporator. This thermistor sends evaporator temperature signals to the processor. The thermistor **must** be replaced when replacing the evaporator fan.

1. Complete evaporator fan procedure.
2. Unsnap the evaporator thermistor from the evaporator and remove it.

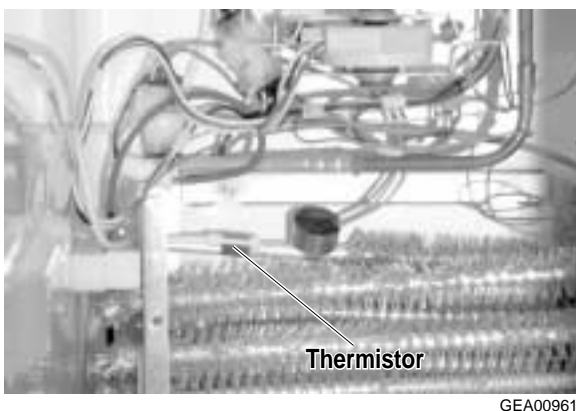

Defrost Thermostat

The defrost thermostat is snapped onto the top portion of the evaporator. The thermostat sends temperature information to the processor. The defrost heater **must** be replaced when replacing the thermostat.

1. Remove the lower fan duct work from the evaporator cover.
2. Remove the 1/4-in. evaporator cover screws and remove the evaporator cover.
3. Disconnect the defrost thermostat wiring connector.
4. Remove the defrost thermostat from the evaporator.

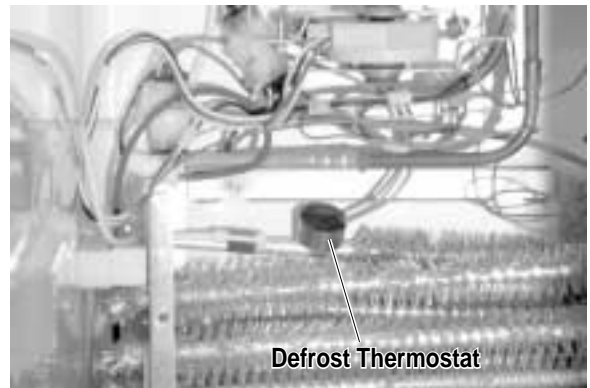

Defrost Heater

The defrost heater is located at the bottom of the evaporator. The defrost heater heats the evaporator in the defrost mode of operation. The thermostat **must** be replaced when replacing the defrost heater.

1. Complete defrost thermostat procedure.
2. Remove Phillips head defrost heater mounting screws (2).
3. Remove the defrost heater.

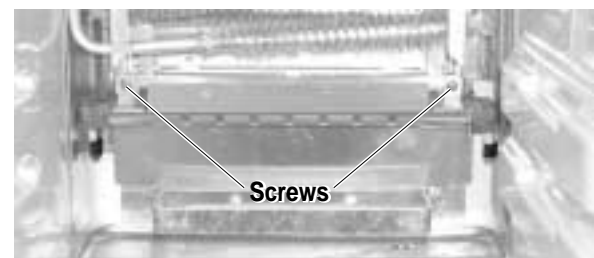

Evaporator Drip Pan

The evaporator drip pan is located under the evaporator. This pan catches condensation from the evaporator that is generated during the defrost mode of operation.

1. Remove 1/4-in. drip pan mounting screws (2).
2. Remove the drip pan.

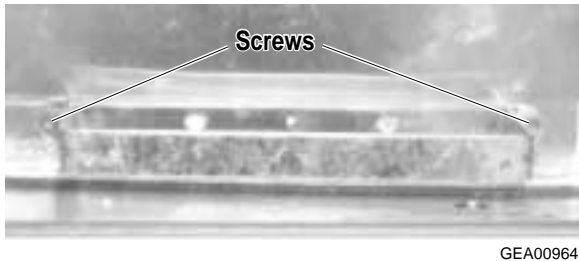

Evaporator

Air is driven across the evaporator coils to produce cold air for the freezer and fresh food compartments.

1. Remove the lower evaporator fan ductwork.
2. Remove 1/4-in. evaporator cover screws (4) and remove the evaporator cover.
3. Remove the defrost thermostat and evaporator thermistor.
4. Remove the defrost heater Phillips head screws (2) and remove the heater.
5. Remove 1/4-in. evaporator mounting screws (4) located at the four corners of the evaporator.

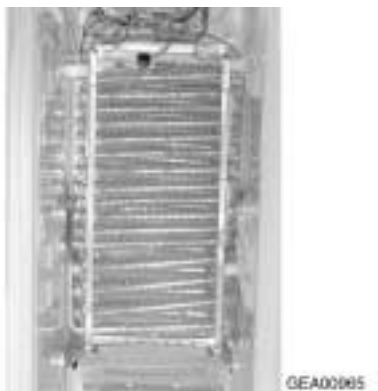

Caution: To prevent damage to the capillary tube, the capillary tube **must** be desoldered first.

6. Desolder the capillary tube from the evaporator.
7. Desolder the suction line. Use a pair of pliers to hold the evaporator.
8. Remove the evaporator.
9. With a file, score the capillary tube just above the soldered section. Break off the soldered section of the capillary tube. This helps prevent solder from plugging the tube during assembly.
10. Place a new evaporator into the freezer and insert the suction and capillary tube into the evaporator.
11. Braze the suction and capillary tube to evaporator using silver solder.
12. Install a replacement dryer.
13. Evacuate and recharge the system using currently accepted procedures.

Freezer Thermistor

The freezer thermistor is located at the center of the right wall in the freezer compartment. It sends temperature signals to the processor.

1. With a small flat-blade screwdriver, unlock the tabs and remove the assembly.
2. Remove the thermistor from the cover and disconnect the wire connector.



Condenser Fan

The condenser fan is located in the rear of the unit. It provides forced-draft cooling for the condenser coil.

1. Remove the 1/4-in. back panel access screws (5) and remove the back panel.



2. Remove the 1/4-in. condenser fan mounting screw and slide the fan out until the wire is exposed.
3. Disconnect the supply wire connector.

Main Processor Card

The main processor card is located in the back of the unit. This card controls the operation of the unit. **If a fan short has occurred, replace the fan prior to the card or the card will be destroyed.**

1. Secure power to the unit.
2. Remove the 1/4-in. processor card panel screws (10) and remove the panel.



3. Disconnect the processor cable connectors.
4. Remove the card by unlocking plastic locks located at the corners of the card.

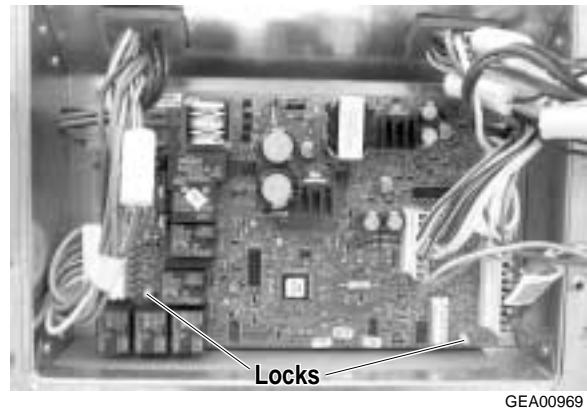

Water Solenoids

When the solenoids receive a signal from the processor, they route water to the filter, cooler, and icemaker.

1. Remove the 1/4-in. rear panel screws (10) and remove the rear panel.
2. Remove the 1/4-in. bracket screw.
3. Slide the solenoid assembly out.

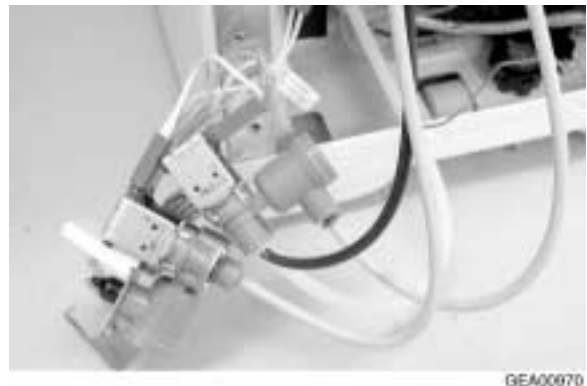

4. Disconnect the cable assembly.
5. Disconnect the water tube. To disconnect the quick connect, push the black collar in and pull the tube out.
6. Remove the solenoid.

Diagnostics

Table of Contents

Efficient Use of Diagnostics	32
Failure Causes (Table 1)	33
Self Diagnostics	33
Diagnostic Tests (Table 2)	35
Communication Tests (0 2, 0 3, or 0 4)	35
Temperature Control Panel Self-Test (0 6)	35
Dispenser Board	36
Control and Sensor System Self-Test (0 7)	36
Main Control Board (Low-Voltage Side)	37
Main Control Board (120-VAC Side)	38
Main Control Board Locator Table (Low-Voltage Side)	39
Main Control Board Locator Table (120-VAC Side)	40
Unit Dead, No Sound & No Cooling (diagnostic chart)	42
Fresh Food Warm - Freezer Warm (diagnostic chart)	43
Fresh Food Warm - Freezer Normal (diagnostic chart)	44
Fresh Food Too Cold - Freezer Normal (diagnostic chart)	45
Freezer Warm - Fresh Food Normal (diagnostic chart)	46
Compressor Not Running (diagnostic chart)	47
Damper Door Not Opening or Not Closing (diagnostic chart)	48
Condenser Fan Not Running (diagnostic chart)	49
Evaporator Fan Not Running (diagnostic chart)	50
Fresh Food Fan Not Running (diagnostic chart)	51
Heavy Frost on Evaporator (diagnostic chart)	52
Thermistor Test (diagnostic chart)	53
Thermistor Values (Table 3)	54

Efficient Use of Diagnostics

For the most efficient use of the diagnostics, find the appropriate diagnostic chart and proceed as directed in the chart. When directed to enter Self Diagnostics, refer to the Self Diagnostics section of this chapter for more information. When directed to perform a diagnostic test (example; encoder test 0 5), refer to Table 2, Diagnostic Key Sequences, for more information.

Table 1. Failure Causes			
Freezer Compartment		Fresh Food Compartment	
Above 15° Fahrenheit	High-resistance freezer thermistor	Above 50° Fahrenheit	High-resistance fresh food compartment thermistor
	Low resistance evaporator thermistor		Damper closed
	Condensor fan failure		Fresh food fan failure
	Evaporator fan failure		Evaporator fan failure
	Defrost heater stuck on		Door switch failure
	Door switch failure		Main control board faulty
	Main control board faulty		Harness faulty
	Harness faulty		Door gasket leak
	Dispenser flap open		Door ajar
	Door gasket leak		
Door ajar			
Sealed system failure			
Cycle Normal (between 14° and -14° Fahrenheit)		Cycle Normal (between 49° and 33° Fahrenheit)	
Below -15° Fahrenheit	Damper stuck closed	Below 32° Fahrenheit	Damper stuck open
	Low-resistance in freezer thermistor circuit		Low-resistance fresh food compartment sensor circuit
	Main control board faulty		Main control board faulty
	Fresh food compartment fan failure		Ambient temperature below 60°
	Harness faulty		Harness faulty

Self Diagnostics

To enter Self Diagnostic mode, both temperature control panel displays must be illuminated. A display can be illuminated by pressing an adjacent temperature adjustment button. When both displays are illuminated, set the freezer and refrigerator temperature settings to 5. Simultaneously press and hold all 4 temperature adjustment buttons for approximately 3 seconds. A flashing 0 in the refrigerator and freezer displays will indicate that the refrigerator is in Self Diagnostic mode.

To perform a self diagnostic test, locate the test in Table 2, Diagnostic Tests.

For temperature control panels with single-digit displays, the COLDER temperature adjustment button will increment the numbers up and the WARMER temperature adjustment button will increment the numbers down. Use the freezer temperature adjustment buttons to enter the test code number in the freezer display. Use the refrigerator temperature adjustment buttons to enter the test code number in the refrigerator display. When a test code has been entered, the displays will flash to confirm the test. Press the HOLD button for 3 seconds to begin the test.

For temperature control panels with 3-digit displays, the COLDER temperature adjustment button will increment the numbers down and the WARMER temperature adjustment button will increment the numbers up. Use the freezer temperature adjustment buttons to enter the test code number in the freezer display. Use the refrigerator temperature adjustment buttons to enter the test code number in

the refrigerator display. When a test code has been entered, the displays will flash to confirm the test code. Press any button other than a temperature adjust button to begin the test.

When testing has been completed, do one of the following things:

- Enter code 1 5 to completely reset the system.
- Enter code 1 6 to exit diagnostic mode. The temperature control panel is reset automatically.
- Unplug the refrigerator for at least 10 seconds. Test mode will terminate when the refrigerator is plugged back in.

Test mode will terminate automatically after 15 minutes of inactivity.

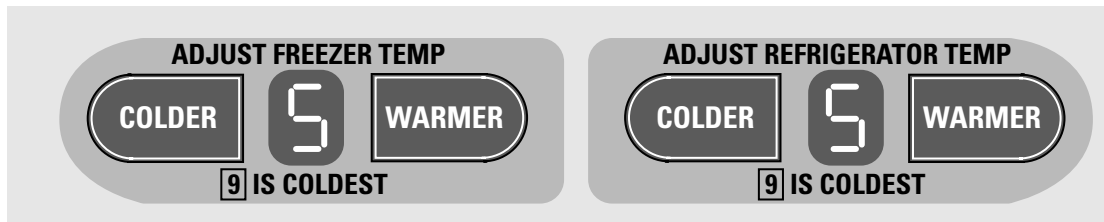

Temperature Control Panel (Single-Digit Display)

Table 2. Diagnostic Tests			
Freezer Display	Refrigerator Display	Mode	Comments
0	2	Temperature control panel to main control board communication	P on the FZ display if OK. F on the FZ display if not OK.
0	3	Temperature control panel to dispenser board communication	P on the FZ display if OK. F on the FZ display if not OK.
0	4	Dispenser board to main control board communication	P on the FZ display if OK. F on the FZ display if not OK.
0	6	Temperature control panel self-test	See Temperature Control Panel Self-Test on page 35.
0	7	Control and sensor system self-test	See Control and Sensor Self-Test on page 36.
1	0	Open damper	Damper will open, pause briefly, then close.
1	1	Fan speed test	Each fan will run for 10 seconds, then stop.
1	2	100% run time	This mode runs the sealed system 100% of the time for 1 hour.
1	3	Enter pre-chill	This places the freezer in pre-chill mode. The refrigerator will return to normal operation on its own.
1	4	Enter defrost	This will set the refrigerator into the defrost mode. If the cabinet is not cold when executed, this mode may execute extremely fast. The refrigerator will return to normal operation on its own.
1	5	Refrigerator reset	Causes a system reset.
1	6	Test mode exit	Causes system to exit test mode and resets temperature control panel.
1	7	Degree C/F	Refrigerator temperature adjust keys can be used to change display from F to C or C to F.

Communication Tests (0 2, 0 3, or 0 4)

A communication test will display the test code while checking communication. When the test has concluded, the freezer display will display a P (passed) or an F (failed) for 2 seconds. After 2 seconds, the displays will show the test code. At this time, a new test code can be entered.

Temperature Control Panel Self-Test (0 6)

This test applies **only** to the temperature control board inside the fresh food compartment.

When the Temperature Control Panel Self-Test is initiated, all of the LEDs and numerical segments in the displays will illuminate. When the SAFE THAW button is pushed, all 3 LEDs for safe thaw should turn off. When the QUICK CHILL button is pressed, all 3 LEDs for the quick chill should turn off. Continue this process for each LED/Button pair on the display. The colder key is to turn off seven-segment LEDs. The warmer key is to turn off the Set LED for both the freezer and the fresh food compartments.

To exit the Temperature Control Panel Self-Test, both of the refrigerator temperature adjust keys **must** be pressed simultaneously for 3 seconds. This can be done at any time to exit the test.

Dispenser Board

No self diagnostic tests exist for the dispenser board. Dispenser board operation is tested by pressing each button and checking for proper operation.

Control and Sensor System Self-Test (0 7)

This test checks all five thermistors located throughout the unit. Once the test is initiated, the test code (0 7) will stop flashing and the thermistor test results will appear on the freezer display in the test order listed below. The thermistor test sequence number will not be shown on the display.

If the unit is not equipped with the Quick Chill option, the third thermistor (quick chill) will display a 0 and 3 audible beeps will sound at the temperature control panel. This is not a failure if the unit is not equipped with the Quick Chill option.

Thermistor test results:

- **P** = Pass
- **0** = Failed
- **S** = Short to 5 VDC
- **B** = Bad amplifier

Thermistor test sequence is:

1. Fresh food top thermistor
2. Fresh food bottom thermistor
3. Quick chill thermistor (displays 0 if unit is not equipped with Quick Chill option)
4. Evaporator thermistor
5. Freezer thermistor

Note: Thermistor test results will be displayed in the sequence shown above. The thermistor test sequence number will not be shown on the display.

Main Control Board (Low-Voltage Side)

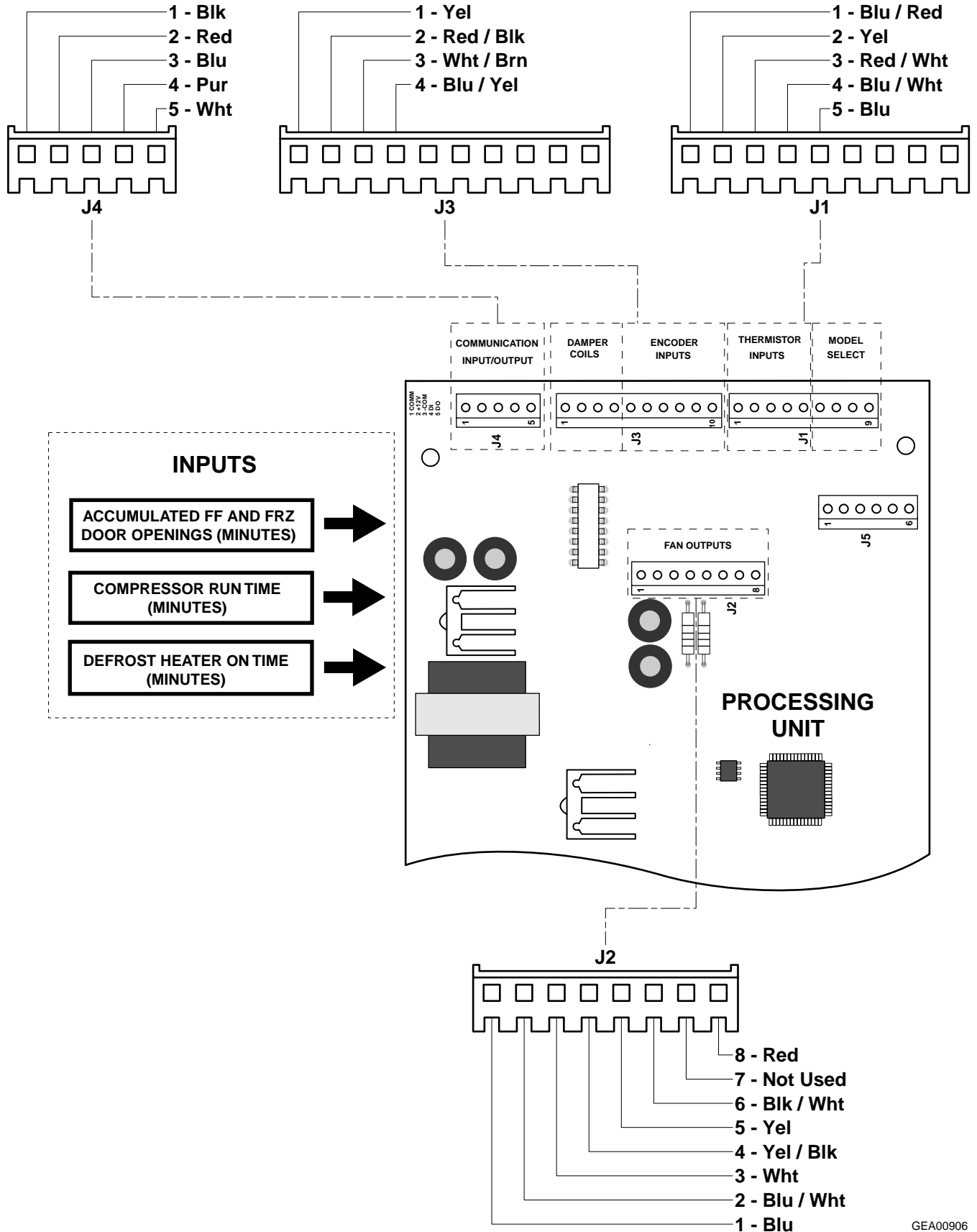

GEA00906

Main Control Board (120-VAC Side)

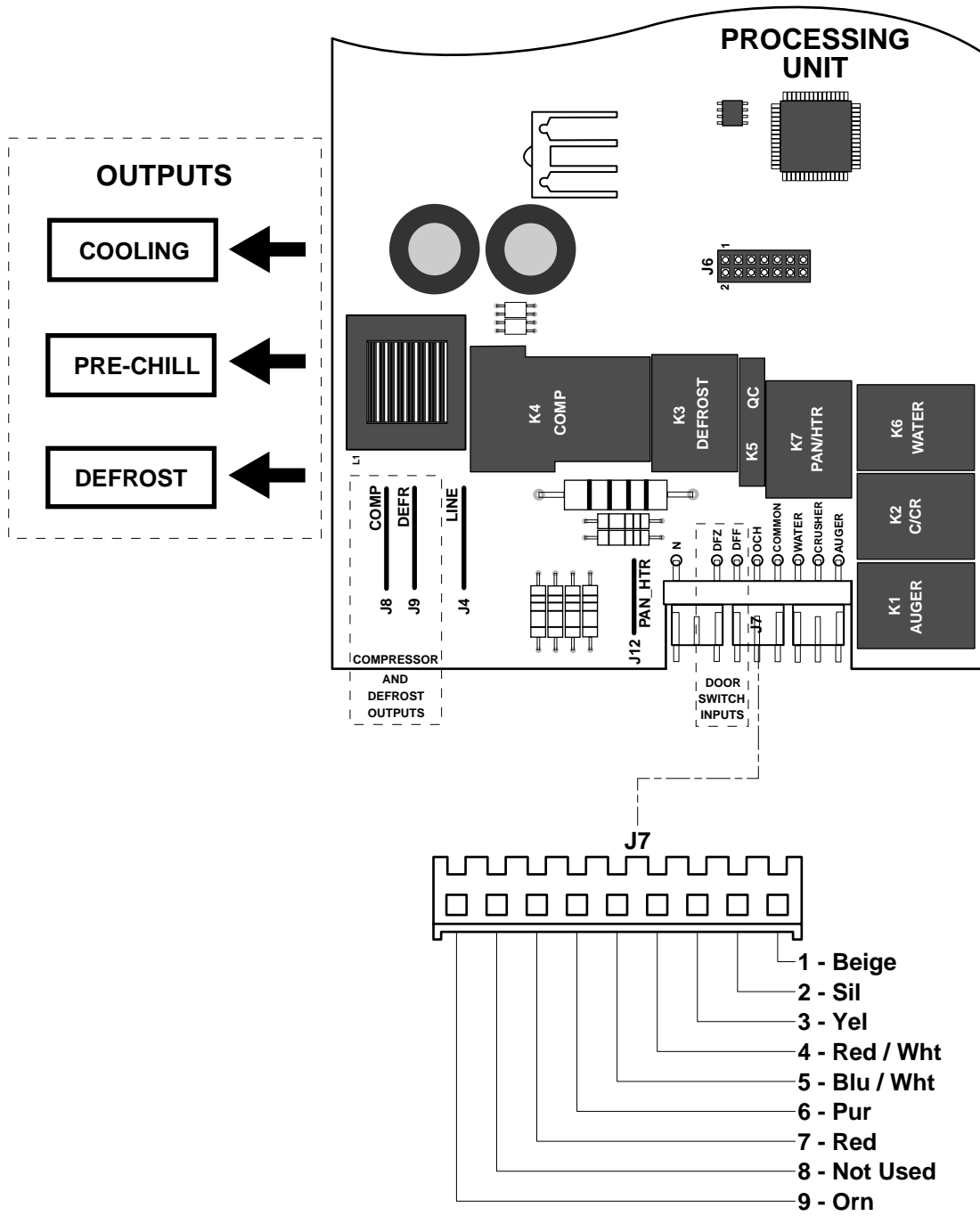

GEA00907

Main Control Board Locator Table (Low Voltage Side)				
Connector	Pin	Wire Color	Component Termination	Pin-to-Pin Voltage Reading
J1	1	Blue/Red	Fresh food thermistor #1	J1 pin 1 to pin 5 = 2.8 to 3.5 VDC
J1	2	Yellow	Fresh food thermistor #2	J1 pin 2 to pin 5 = 2.8 to 3.5 VDC
J1	3	Red/White	Freezer thermistor	J1 pin 3 to pin 5 = 2.8 to 3.5 VDC
J1	4	Blue/White	Evaporator thermistor	J1 pin 4 to pin 5 = 2.8 to 3.5 VDC
J1	5	Blue	Thermistor supply voltage (5 VDC)	J1 pin 5 to J4 pin 3 = 5 VDC
J2	1	Blue	Evaporator fan tachometer	J2 pin 1 to pin 3 = 6.3 VDC
J2	2	Blue/White	Fan input	J2 pin 2 to pin 3 = 12 VDC
J2	3	White	Fan common	J2 pin 3 to pin 8 = 12 VDC
J2	4	Yellow/Black	Evaporator fan	J2 pin 4 to pin 3 = 12.4 VDC (high speed), 8 VDC (low speed)
J2	5	Yellow	Condenser fan	J2 pin 5 to pin 3 = 13.4 VDC (condenser fan is single speed)
J2	6	Black/White	Fresh food fan	J2 pin 6 to pin 3 = 0 VDC (high speed), 3 VDC (low speed)
J2	7	Not used	Not applicable	Not applicable
J2	8	Red	Fan supply voltage (12 VDC)	J2 pin 8 to pin 6 = 13.4 VDC (high speed), 9 VDC (low speed) J2 pin 8 to J4 pin 3 = 13.4 VDC
Continued on next page.				

Main Control Board Locator Table
(Low Voltage Side)

Connector	Pin	Wire Color	Component Termination	Pin to Pin Voltage Reading
J3	1	Yellow	Damper	J3 pin 1 to J4 pin 3 = Standing Voltage 2.3 VDC Traveling Voltage 6.0 VDC
J3	2	Red/Black	Damper	J3 pin 2 to J4 pin 3 = Standing Voltage 2.3 VDC Traveling Voltage 6.0 VDC
J3	3	White/Brown	Damper	J3 pin 3 to J4 pin 3 = Standing Voltage 2.3 VDC Traveling Voltage 6.0 VDC
J3	4	Blue/Yellow	Damper	J3 pin 4 to J4 pin 3 = Standing Voltage 2.3VDC Traveling Voltage 6.0 VDC
J4	1	Black	Dispenser board common transmit/receive	See schematic
J4	2	Red	Dispenser board common 12 VDC	See schematic
J4	3	Blue	Dispenser board common ground	See schematic

Continued on next page.

Main Control Board Locator Table (120-VAC Side)				
Connector	Pin	Wire Color	Component Termination	Pin to Pin Voltage Reading
J7	1	Beige	Augermotor	J7 pin 1 to J7 pin 9 + 120 VAC
J7	2	Silver	Cube solenoid	J7 pin 2 to J7 pin 9 + 120 VAC
J7	3	Yellow	Water valve	J7 pin 3 to J7 pin 9 + 120 VAC
J7	4	Red/White	Augermotor interlock	J7 pin 4 to J7 pin 9 + 120 VAC
J7	5	Blue/White	Quick chill heater	J7 pin 5 to J7 pin 9 + 120 VAC
J7	6	Purple	Fresh food door light switch feedback	J7 pin 6 to J7 pin 9 + 120 VAC
J7	7	Red	Freezer door light switch feedback	J7 pin 7 to J7 pin 9 + 120 VAC
J7	8	Not used	Not used	Not used
J7	9	Orange	Neutral	Neutral

Unit Dead, No Sound & No Cooling

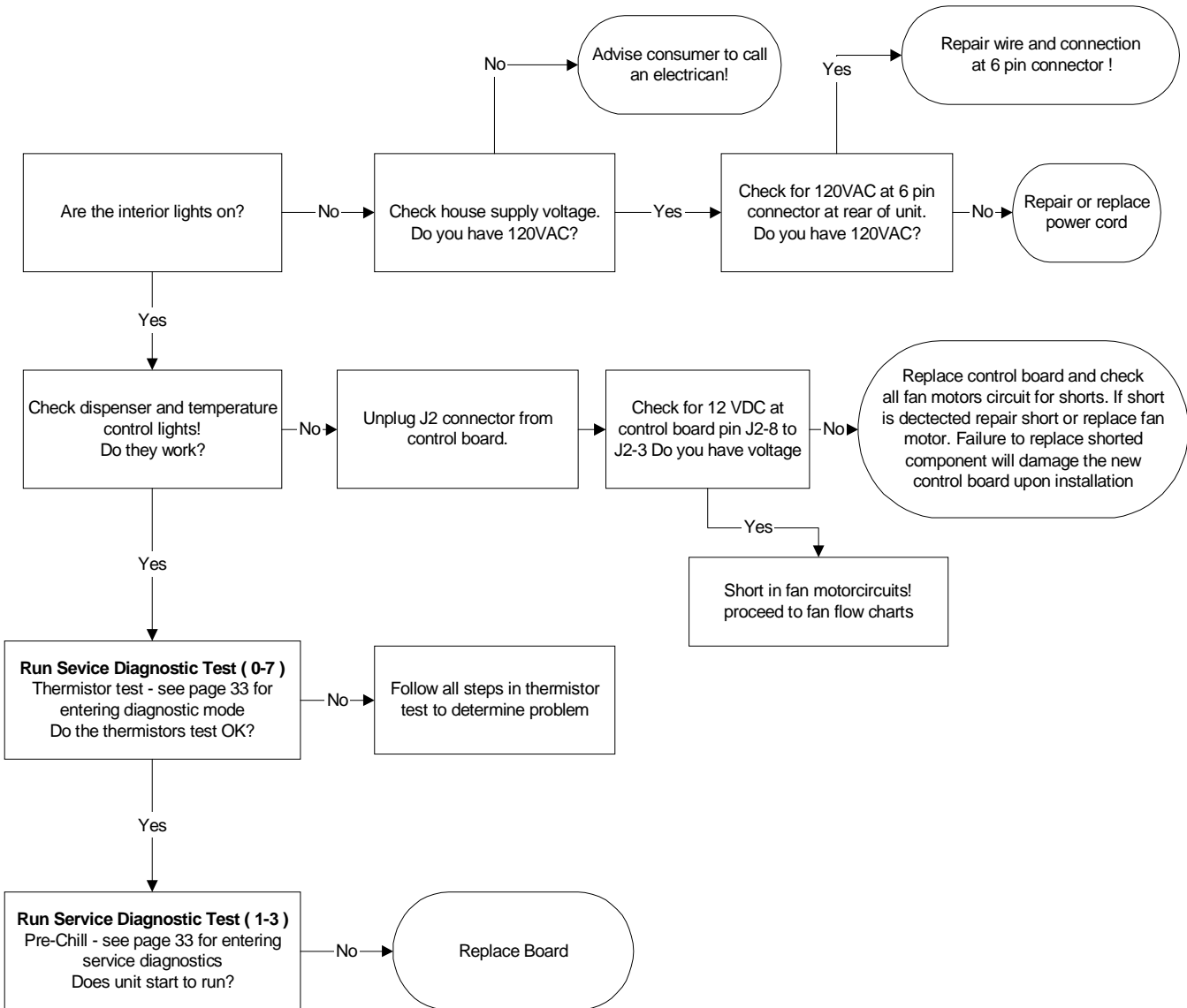

Caution: Unplug power when disconnecting and connecting connectors on the board.

Fresh Food Warm - Freezer Warm

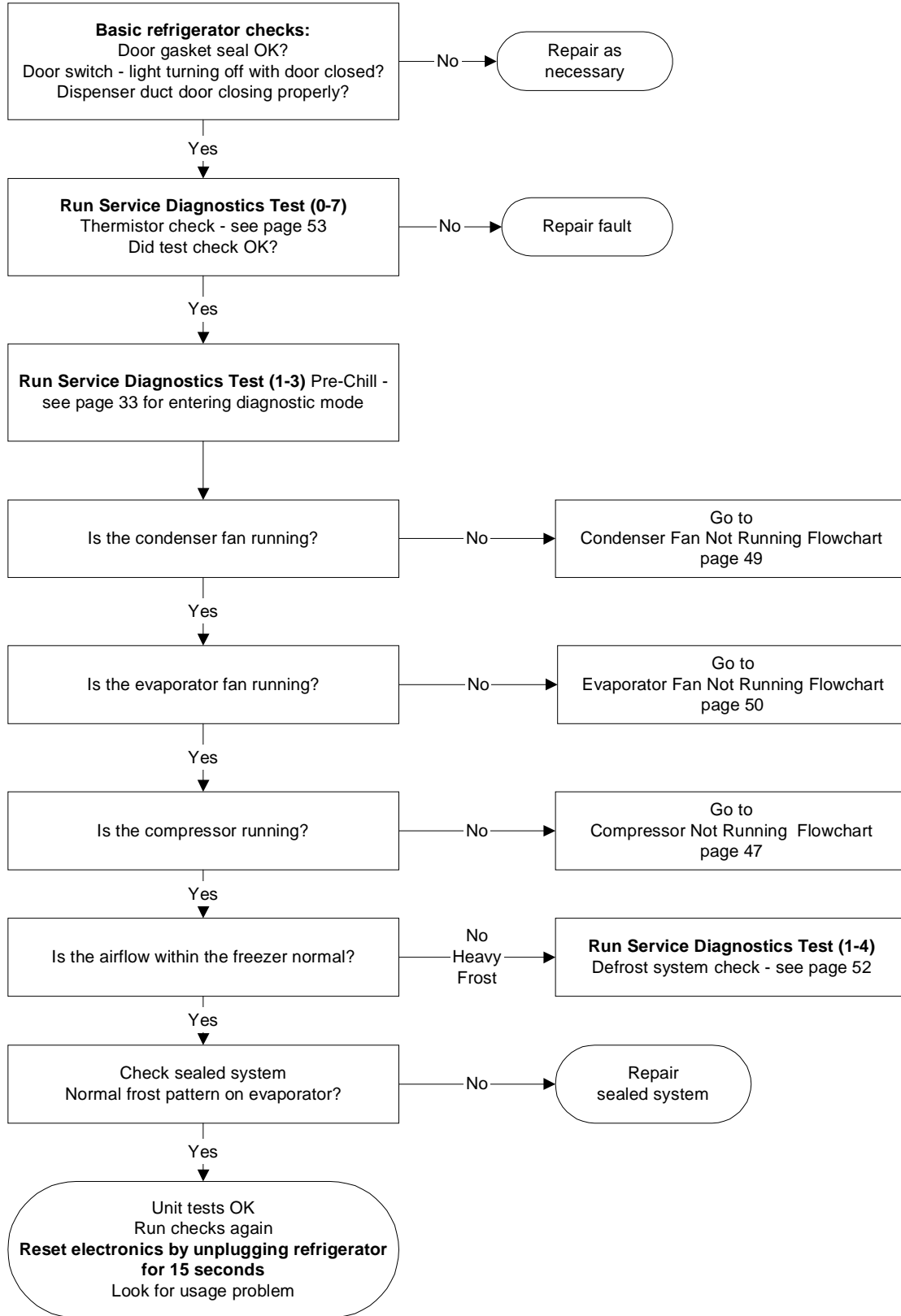

Fresh Food Warm - Freezer Normal

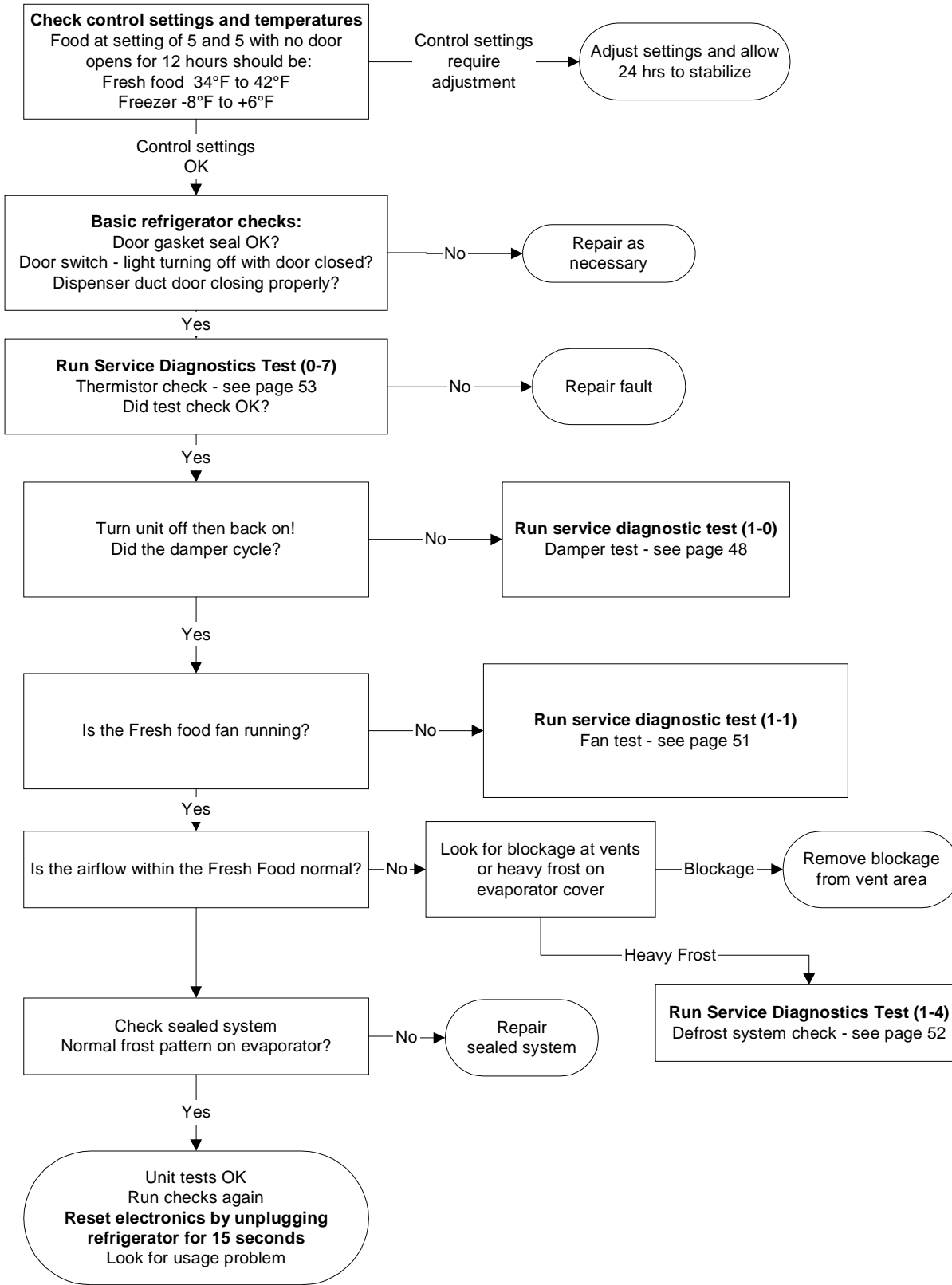

Fresh Food Too Cold - Freezer Normal

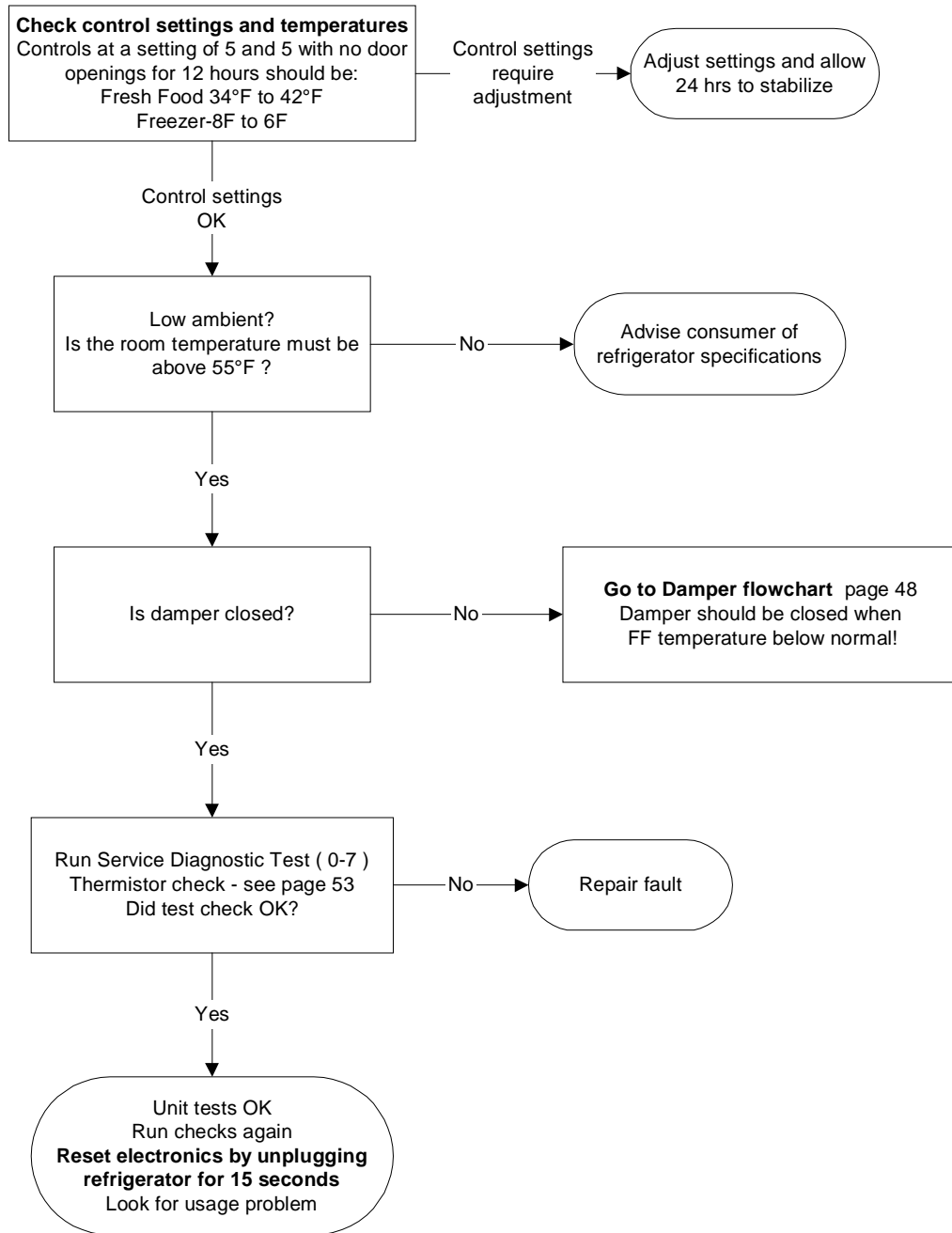

Freezer Warm - Fresh Food Normal

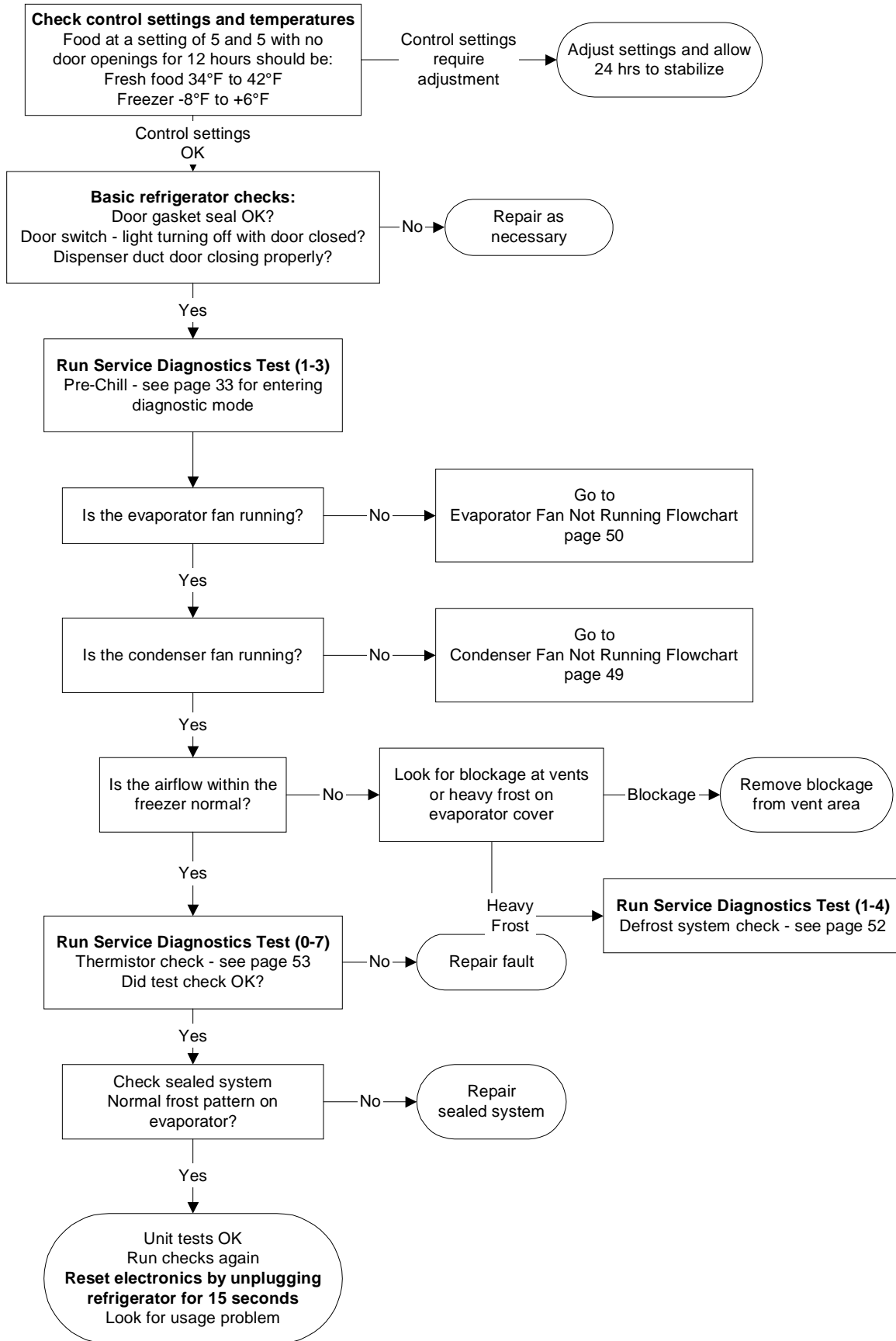

Compressor Not Running

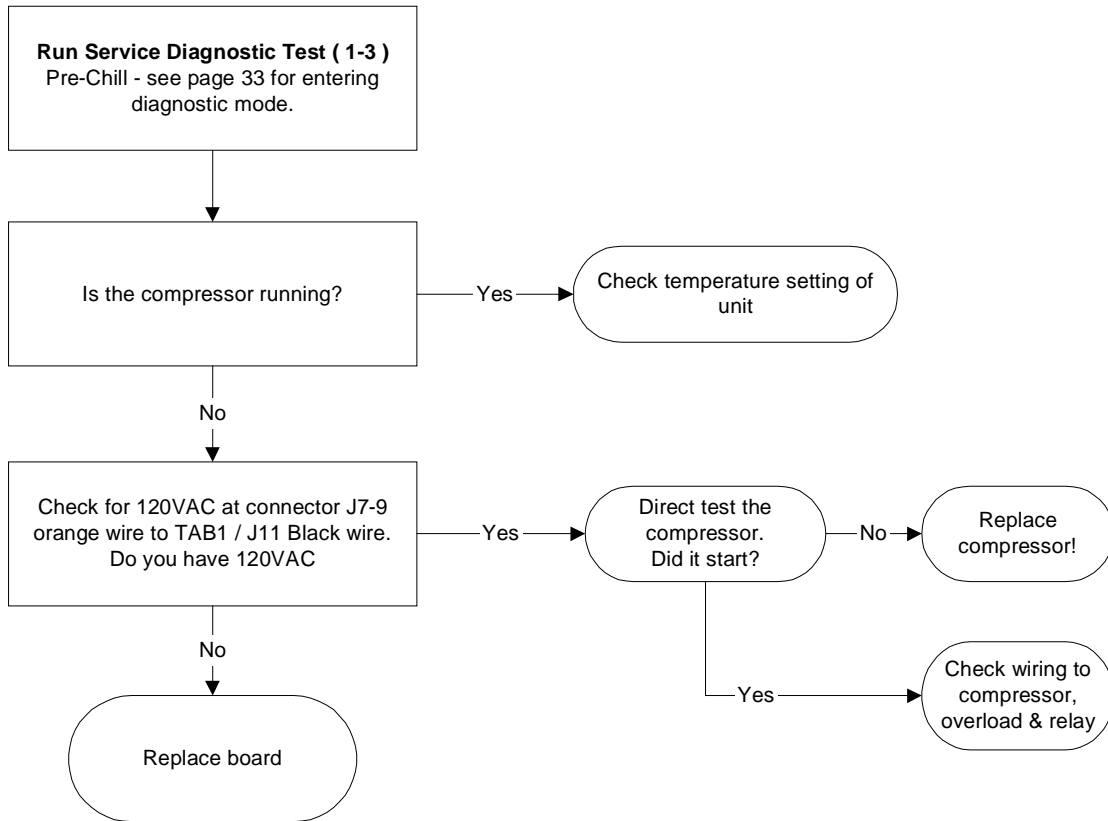

Caution: Unplug power when disconnecting and connecting connectors on the board.

Damper Door Not Opening or Not Closing

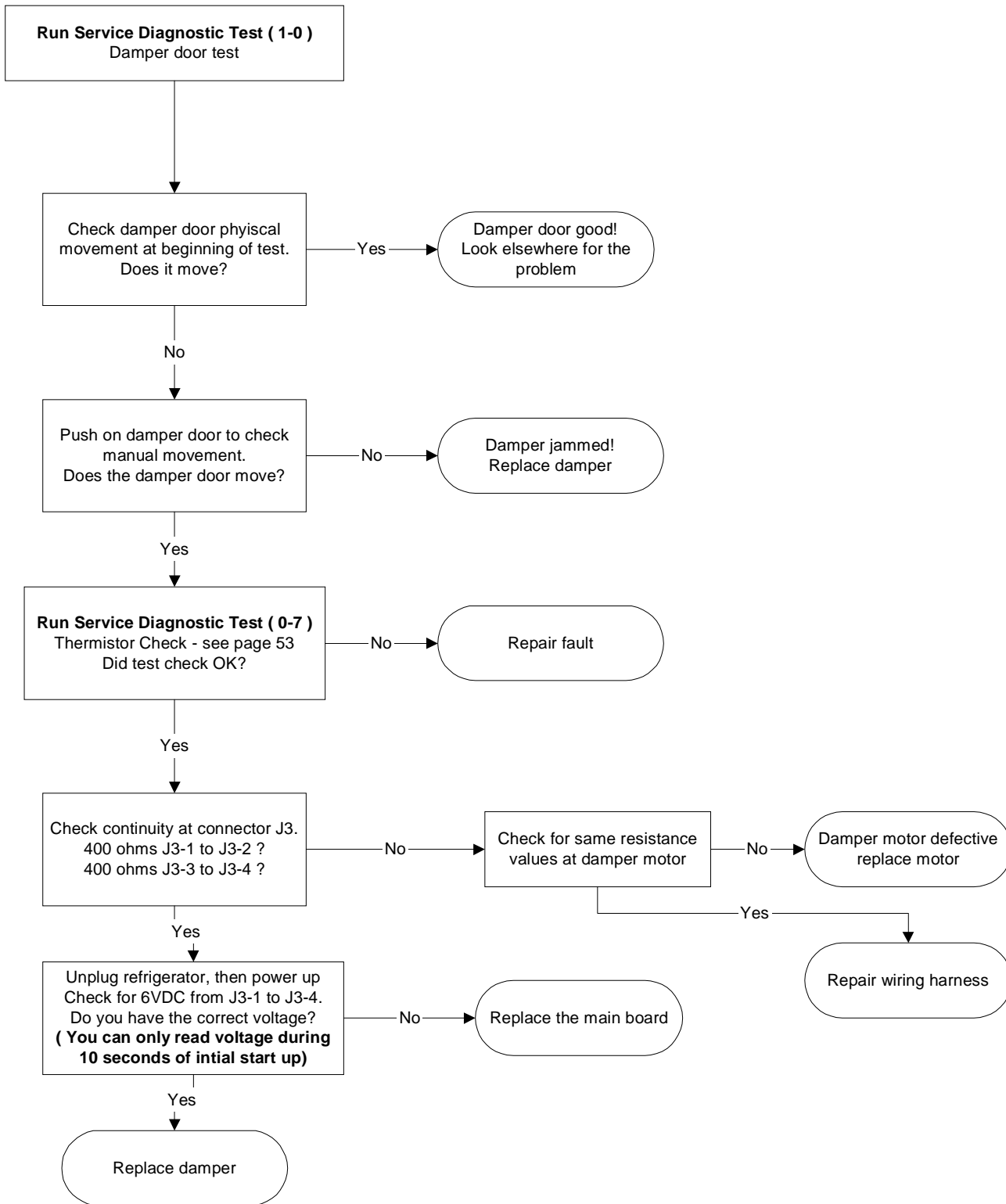

Caution: Unplug power when disconnecting and connecting connectors on the board.

Condenser Fan Not Running

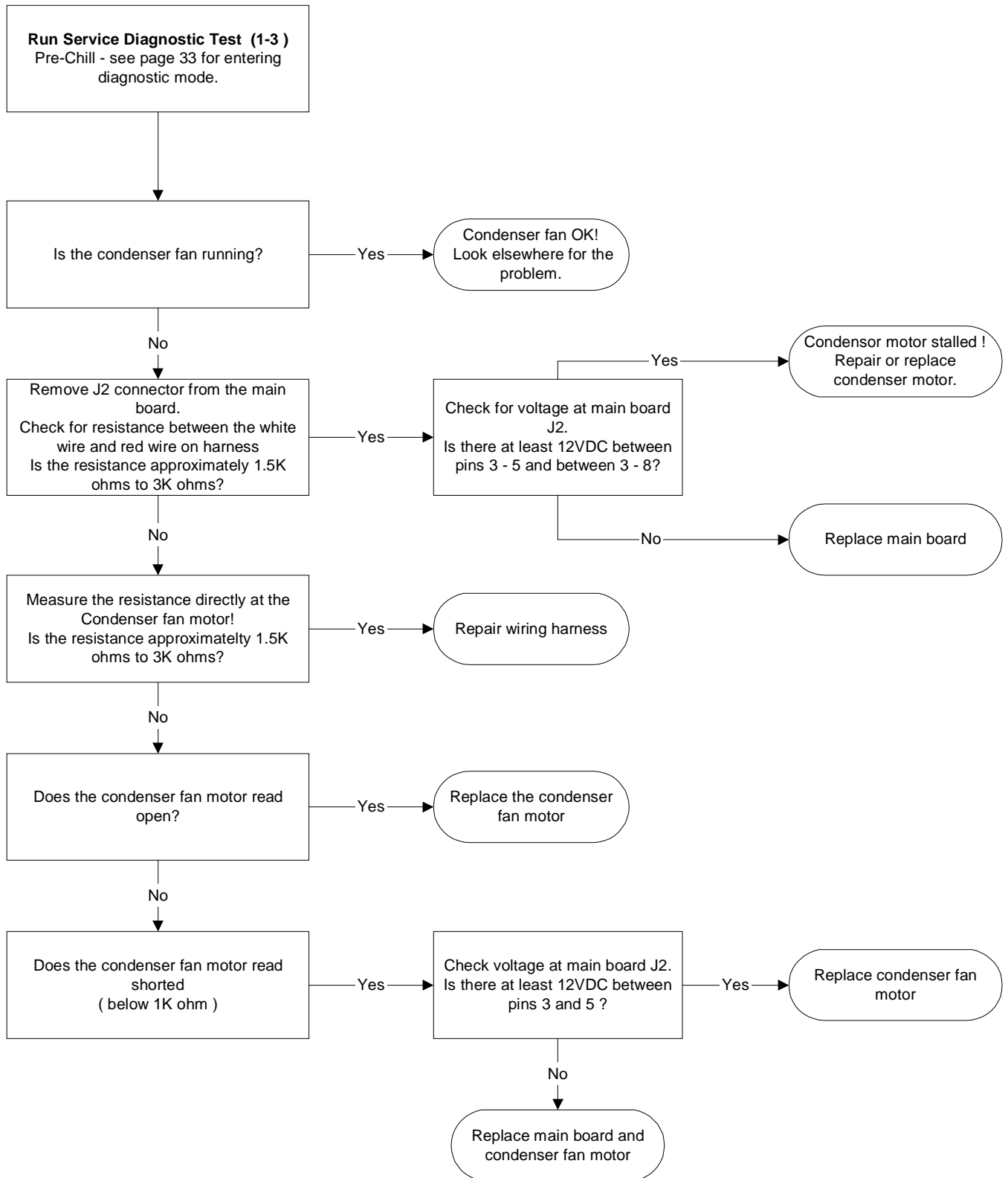

Caution: Unplug power when disconnecting and connecting connectors on the board.

Evaporator Fan Not Running

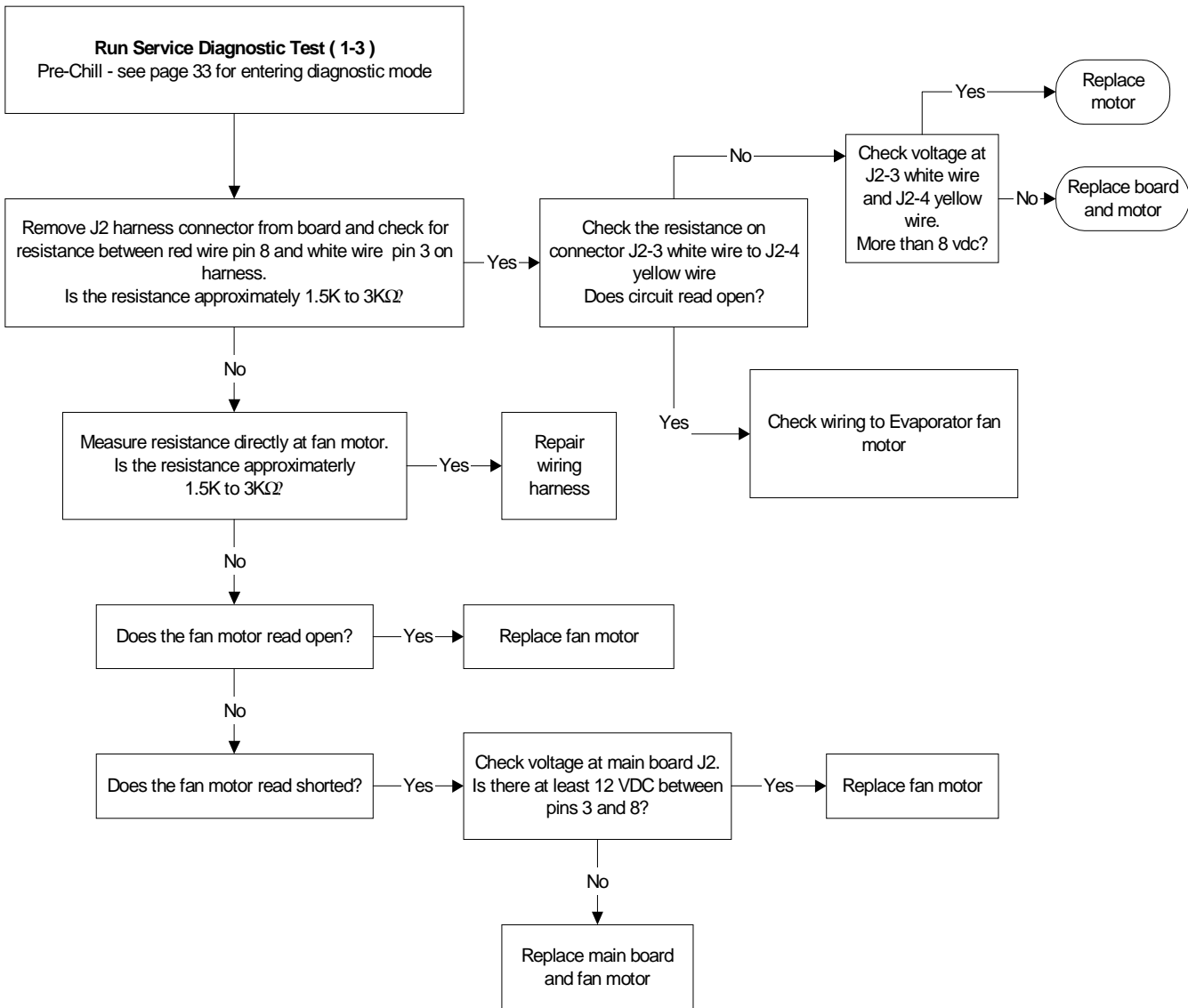

Caution: Unplug power when disconnecting and connecting connectors on the board.

Fresh Food Fan Not Running

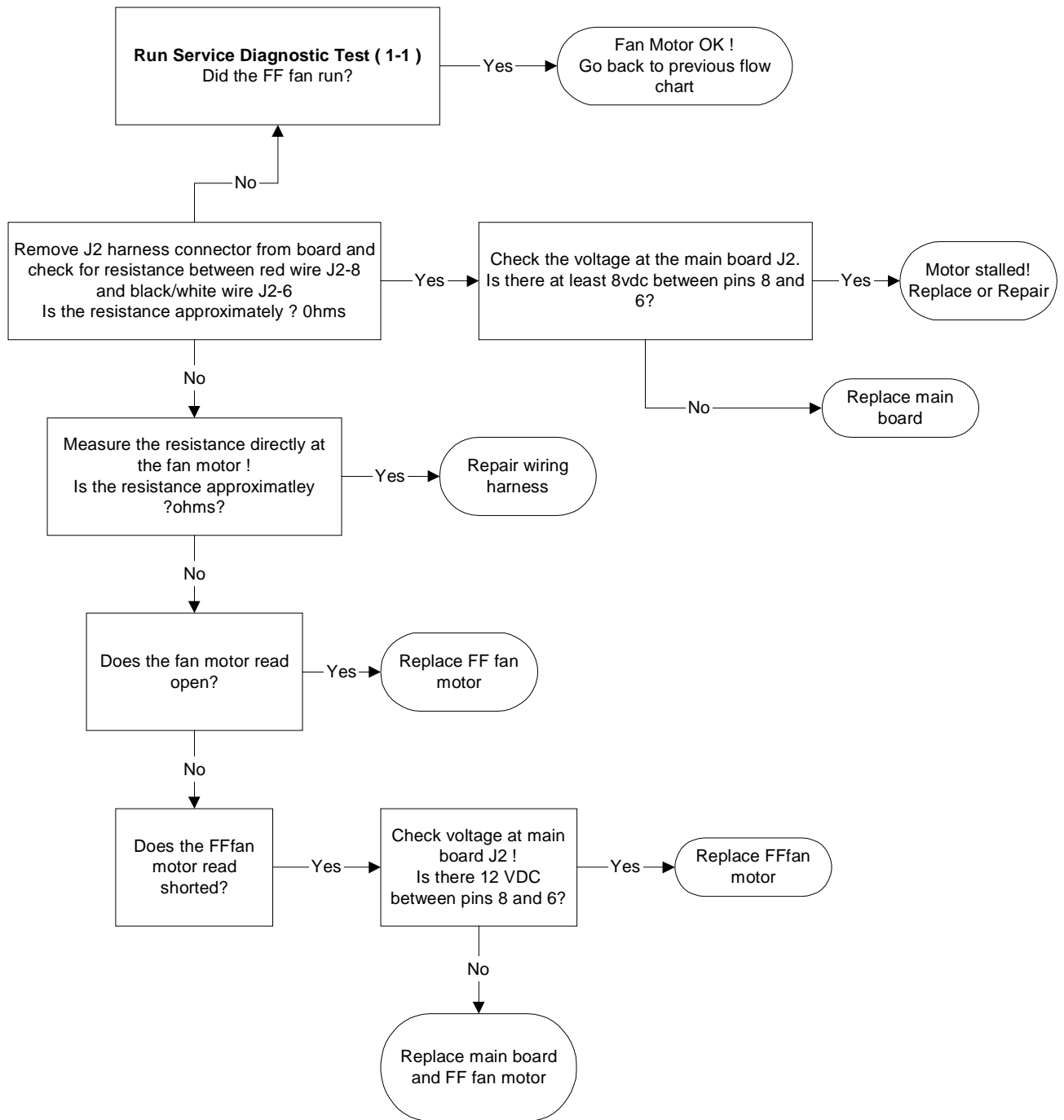

Caution: Unplug power when disconnecting and connecting connectors on the board.

Heavy Frost on Evaporator

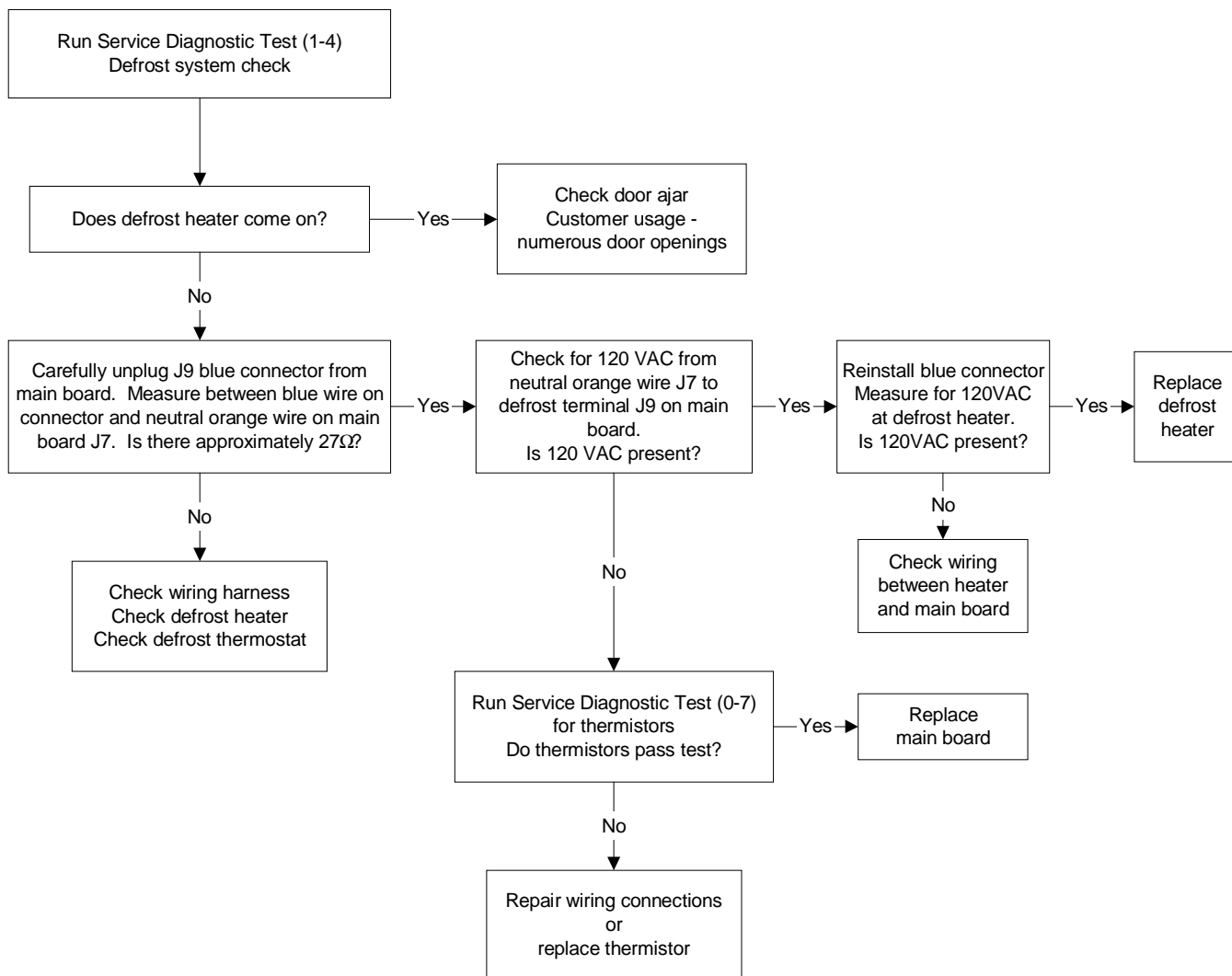

Caution: Unplug power when disconnecting and connecting connectors on the board.

Thermistor Test

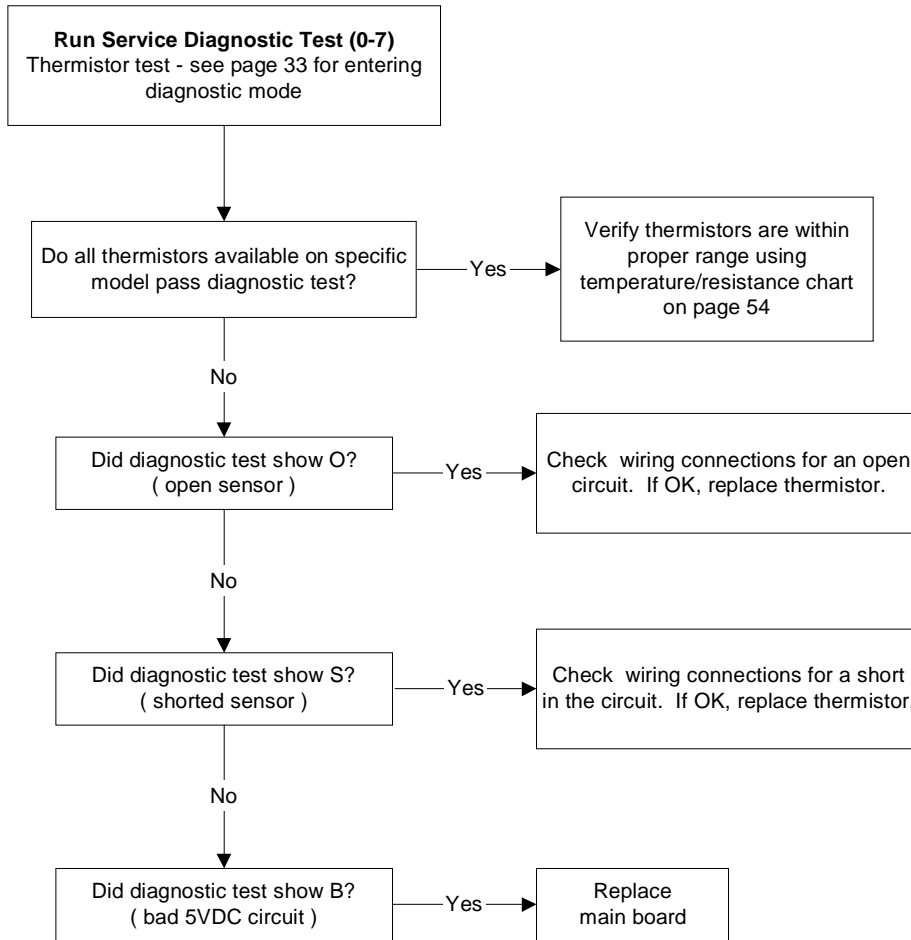
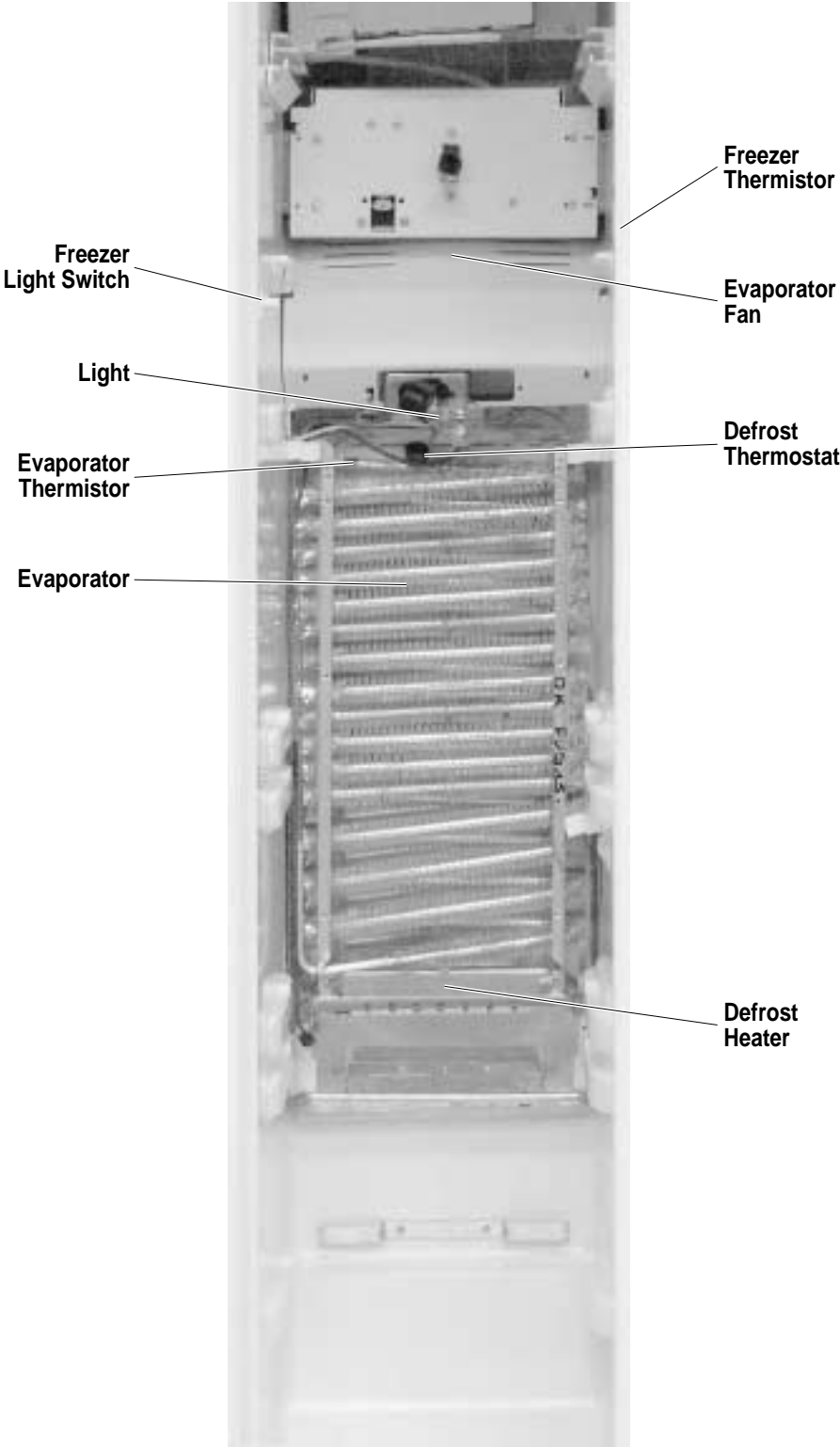

Table 3. Thermistor Values		
Temperature Degrees (C)	Temperature Degrees (F)	Resistance in Kilo-Ohms
-40	-40	166.8 kΩ
-35	-31	120.5 kΩ
-30	-22	88 kΩ
-25	-13	65 kΩ
-20	-4	48.4 kΩ
-15	5	36.4 kΩ
-10	14	27.6 kΩ
-5	23	21 kΩ
0	32	16.3 kΩ
5	41	12.7 kΩ
10	50	10 kΩ
15	59	7.8 kΩ
20	68	6.2 kΩ
25	77	5 kΩ
30	86	4 kΩ
35	95	3.2 kΩ
40	104	2.6 kΩ
45	113	2.2 kΩ
50	122	1.8 kΩ
55	131	1.5 kΩ
60	140	1.2 kΩ

NOTE: The thermistor's resistance has a negative coefficient. As the temperature increases, the thermistor's resistance decreases.

Component and Connector Locator Views



GEA00978

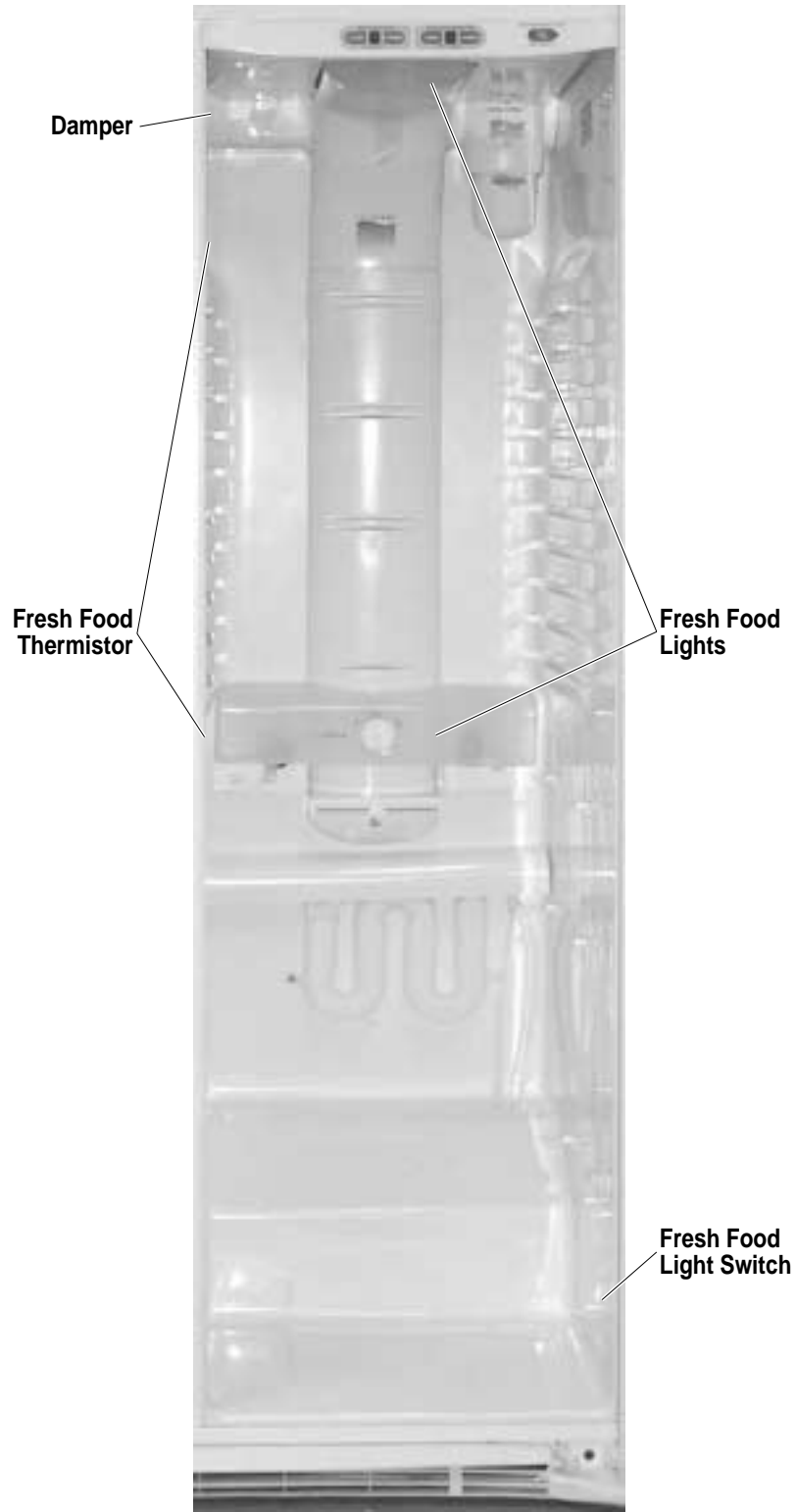

GEA00980

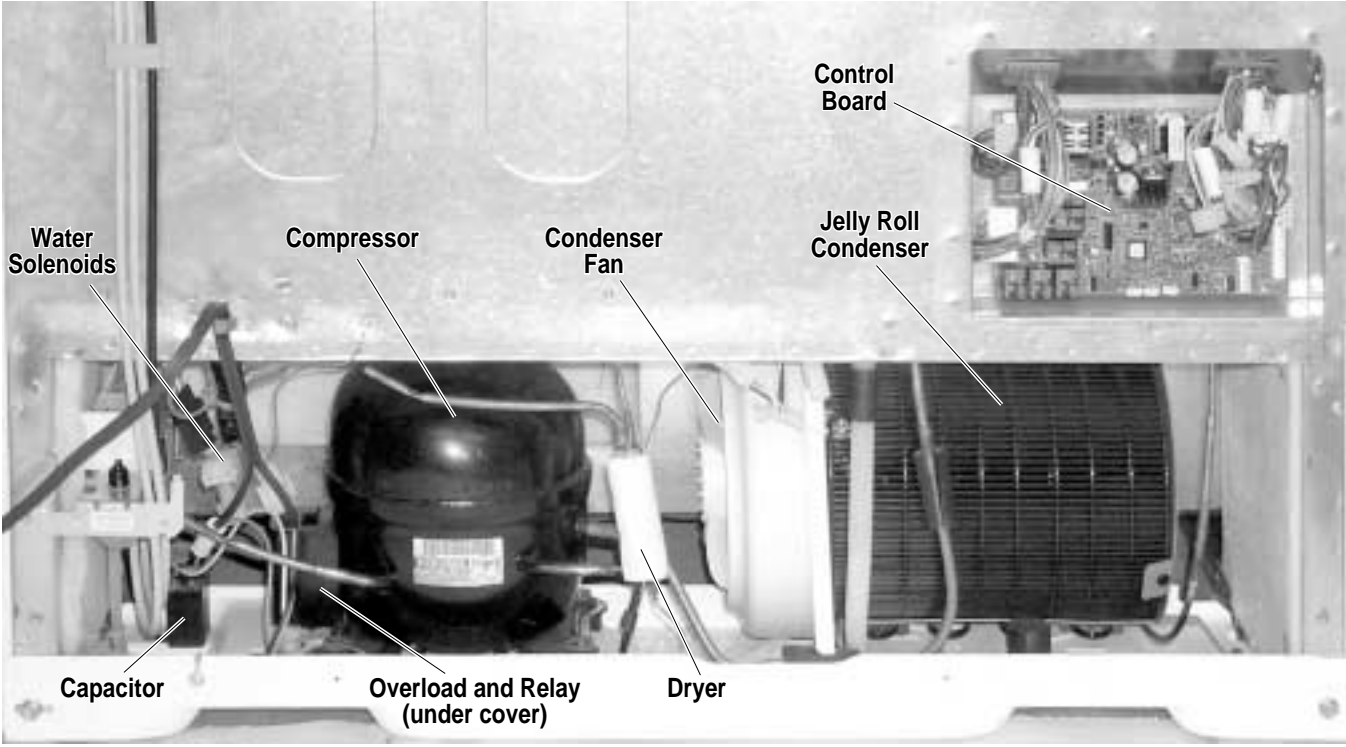

GEA00977

Main Control Board (Low-Voltage Side)

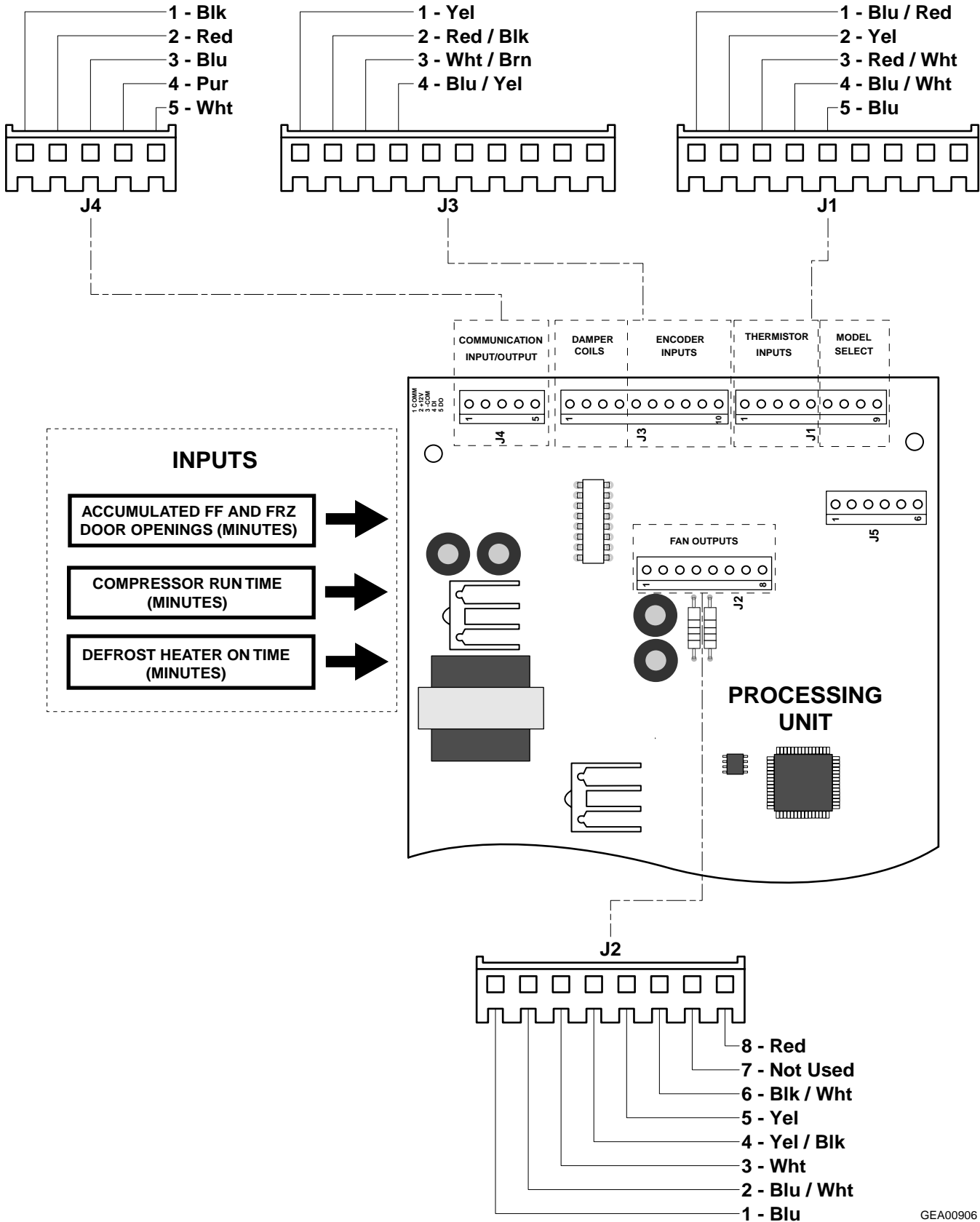

GEA00906

NOTE: Refer to the Main Control Board Locator Tables in the Diagnostics chapter for more information.

Main Control Board (120-VAC Side)

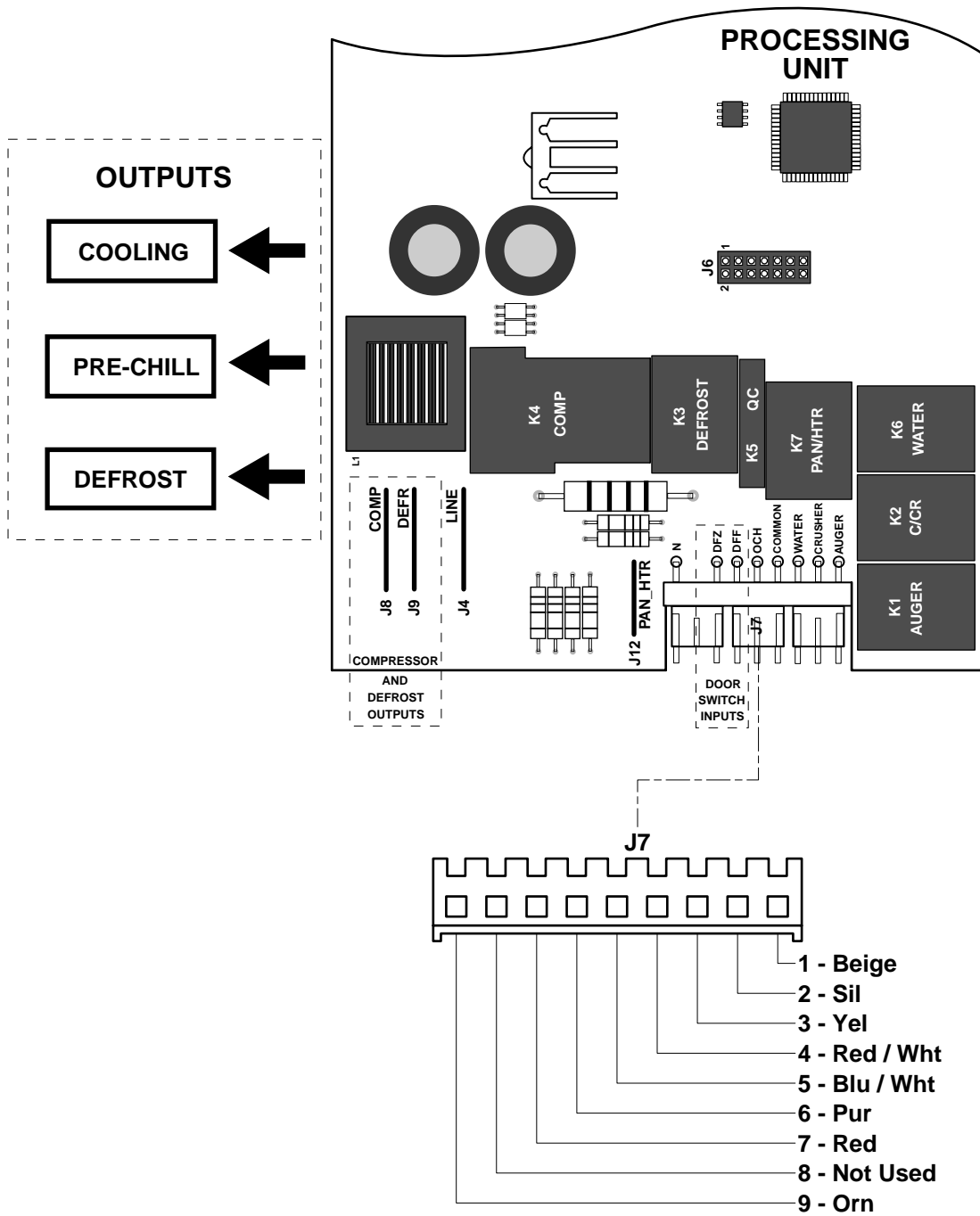

GEA00907

NOTE: Refer to the Main Control Board Locator Tables in the Diagnostics chapter for more information.

Thermistor Locator

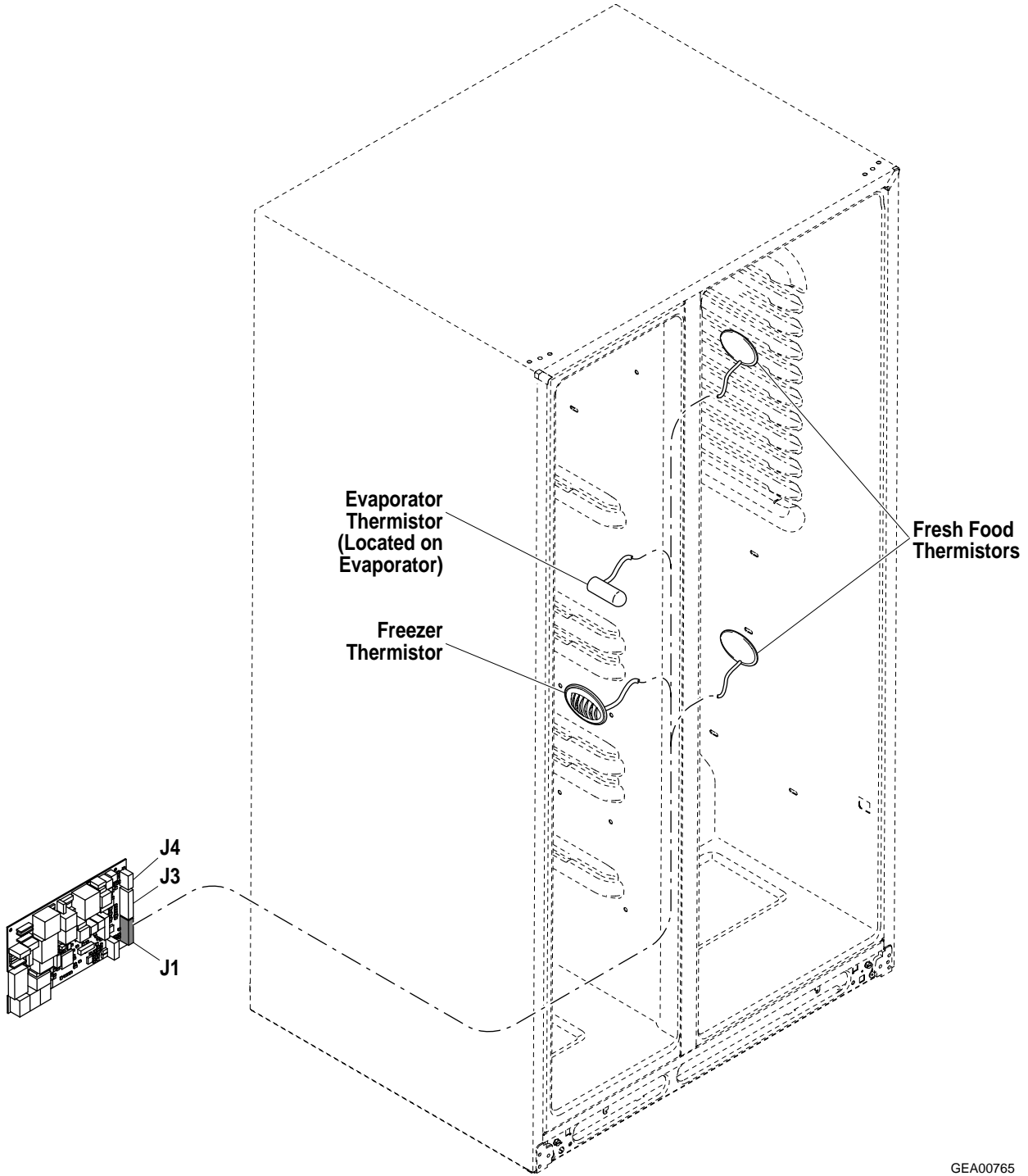

GEA00765

Schematics

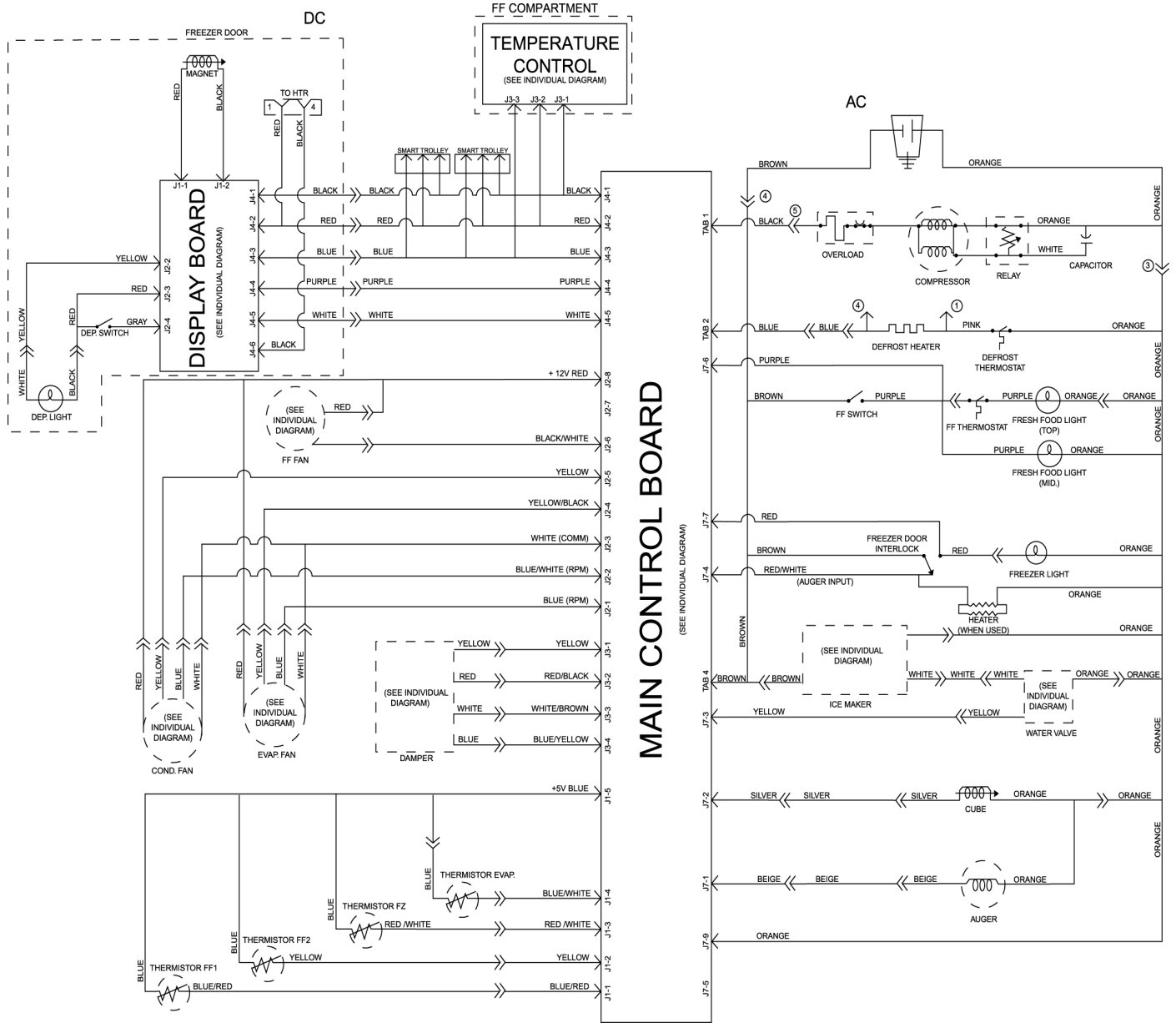

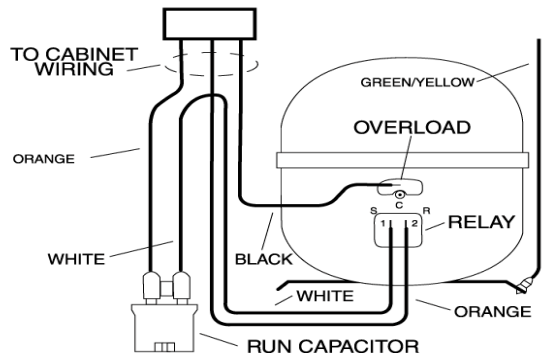
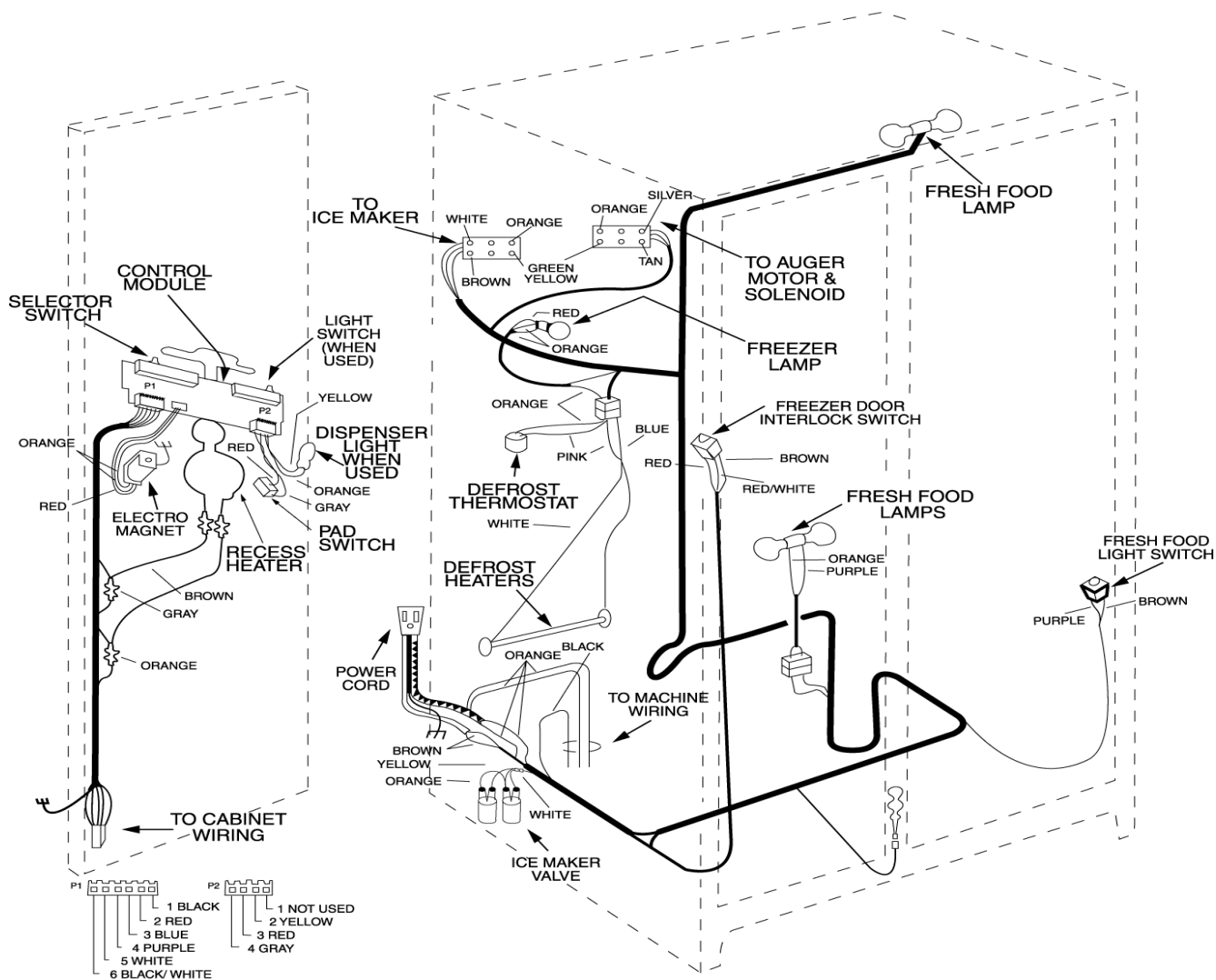

Ref No	Part Number	Description	Qty
1	49-60104-1	GUIDE OWNERS	1
1	31-51333	MINI MANUAL WIRING	1
7	WR12X10430	HANDLE SXS ASM BK	2
11	WR38X10219	RECESS TRIM BOWED BK	1
12	WR02X10782	STOP DOOR	2
14	WR24X10072	GASKET DOOR FZ BK	1
15	WR02X10779	CAM CLOSURE FZ BK	1
23	WR71X10254	MODULE SHELF FZ FIXED	1
31	WR17X10895	GRILLE RECESS	1
36	WR62X10020	SOLENOID ASM	1
56	WR02X10675	LIGHT DISPENSER	1
57	WR02X10670	REFLECTOR LIGHT	1
58	WR17X10813	HOUSING SHIELD DISP WH	1
61	WR02X9561	SOCKET LAMP E12	1
62	WR17X3093	DOOR RECESS ASM	1
69	WR17X10743	FUNNEL ICE DISP BK	1
72	WR23X10171	SWITCH	1
74	WR02X10584	SPRING FUNNEL	1
76	WR02X8933	SLEEVE WATER LINE	1
80	WR02X10471	UNION CONNECTOR	1
90	WR55X10063	BOARD ASM DISP	1
121	WR12X10429	TRIM HANDLE LOWER BK	2
122	WR71X10256	MODULE SUPPORT FZ	2
123	WR71X10255	MODULE SUPPORT FZ	1
124	WR21X10024	BASKET WIRE TILTOUT FZ	1
125	WR21X10025	BASKET WIRE TILTOUT FZ	2
152	WR01X10038	SCR 8-18 AB FLTR 5/8 S	10
154	WR01X10213	SCR 8-18 AB RNT20 5/8 S	8
155	WR02X10643	BRACKET HANDLE LOCK	4

Ref No	Part Number	Description	Qty
159	WR14X10067	FOAM STRIP SE ADH	1
160	WR14X10068	FOAM STRIP SE ADH	1
161	WR17X10817	TOWER AIR FZ LOWER	1
162	WR02X10634	REFLECTOR FZ	1
163	WR71X10252	SHELF FZ UPPER	1
164	WR14X10074	GASKET PLENUM	1
165	WR14X10065	GASKET PLENUM	1
167	WR17X10838	PLENUM FAN EVAPORATOR	1
168	WR02X10674	BRACKET FZ TOWER LOWER	1
175	WR01X10035	SCR 8-18 AB IHW 5/8 S	19
213	WR17X10836	COVER EVAPORATOR FRONT	1
214	WR14X10072	GASKET EVAP COVER	2
215	WR01X10211	BRACKET FZ TOWER UPPER	2
227	WR23X10142	HARNESS DEF HEATER	1
229	WR02X10552	CLIP EVAP THERMISTOR	1
230	WR51X10030	HEATER & BRACKET ASM	1
231	WR02X10669	BLOCK EVAP SEAL	3
232	WR17X10811	SHIELD TROUGH ASM	1
233	WR55X10026	SENSOR TEMP FZ	1
234	WR02X10647	GRILLE SENSOR	3
235	WR02X10668	SHUNT SENSOR	3
238	WR02X10667	BRACKET EVAP COVER	1
240	WR50X10015	THERMOSTAT DEFROST	1
241	WR55X10025	SENSOR TEMP FF	1
247	WR17X10812	ORIFICE FAN ASM	1
248	WR14X10066	GASKET PLENUM	1
249	WR14X10073	GASKET PLENUM	1
250	WR14X10069	FOAM STRIP SE ADH	1
258	WR17X10840	SHIELD LIGHT FZ	1

Ref No	Part Number	Description	Qty
261	WR13X10160	HINGE BTM & PIN ASM	1
268	WR01X10210	SCREW MOBILITY	4
278	WR02X10636	MOBILITY FRONT ASM	2
280	WR02X10781	CAP CORNER OC BK	2
288	WR74X10064	GRILL BASE ASM	1
289	WR02X7646	CLIP BASE GRILLE	2
433	WR02X9391	SOCKET & TERMINAL ASM	3
437	60A	LAMP 60 W	1
447	WR02X10783	COVER HINGE	1
448	WR13X10135	HINGE TOP & PIN ASM	1
552	WR01X2022	SCR 12-24 TT OVT .900 S	10
607	WR23X10174	HARNES DC FZ INTERMEDIA	1
608	WR23X10179	SWITCH LIGHT	1
610	WR60X10043	MOTOR DC EVAP FAN	1
611	WR02X10548	BRACKET EVAP FAN BTM	1
612	WR02X10653	BRACKET ORIFICE FAN	1
613	WR60X10055	BLADE EVAP FAN ASM	1
614	WR02X10540	BUMPER LID	4
615	WR02X10519	GROMMET EVAP FAN	2
808	WR02X4039	ADHESIVE CLIP	2
809	WR01X1936	FASTENER WATER TUBE	1
843	WR11X10010	LEVER ASM FZ	1
847	WR01X2027	SPRING CLOSURE	2

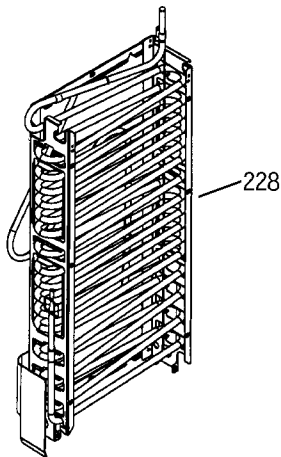

There are two approved evaporator replacement methods. The Lokring® method requires no brazing, by utilizing tight mechanical connections. The heat shield uses the traditional brazing method, but provides protection to the upper liner while brazing the evaporator connections in the freezer compartment.

Always add a new filter drier when servicing the sealed system. Follow each step of the instructions included with the replacement evaporator.

LOKRING® METHOD

LokRing® is a method of installing the evaporator in the freezer without the use of a torch. It utilizes a mechanical connection rather than a brazed connection. Apply a few drops of LokPrep (a special cleaning and sealing solution), to the ends of the tubing that you wish to join together. The LokRing® tool compresses the connector to ensure a tight mechanical connection. The parts shown to the right are required for the LokRing® replacement method.

For additional information on how to use LokRing®, call 1-800-848-7722 & order publication # 31-9067 (LokRing repair procedures manual) and publication # 31-9066 (Lokring repair procedures VHS video tape).

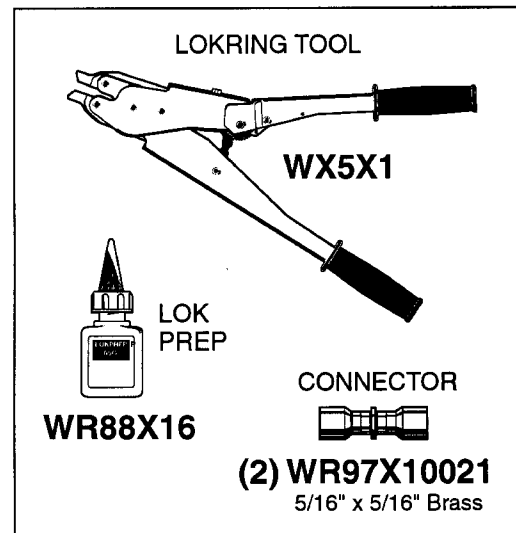

HEAT SHIELD METHOD

The heat shield kit is used to prevent damage to the refrigerator liner when brazing the evaporator into the sealed system. Refer to the instructions included in the heat shield kit. The kit comes with enough heat absorbing paste, solder and tape to complete four repairs.

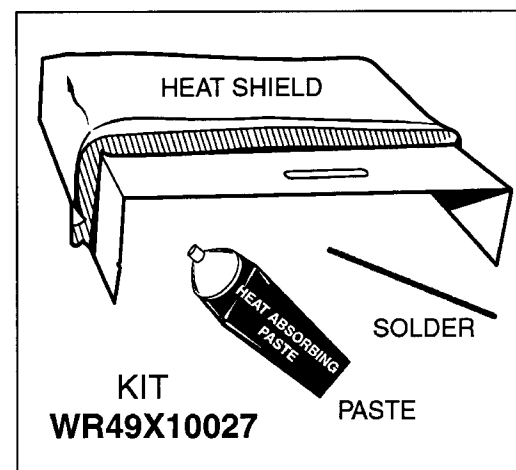

Ref No.	Part Number	Description
228	WR85X10022	Low Side Assembly

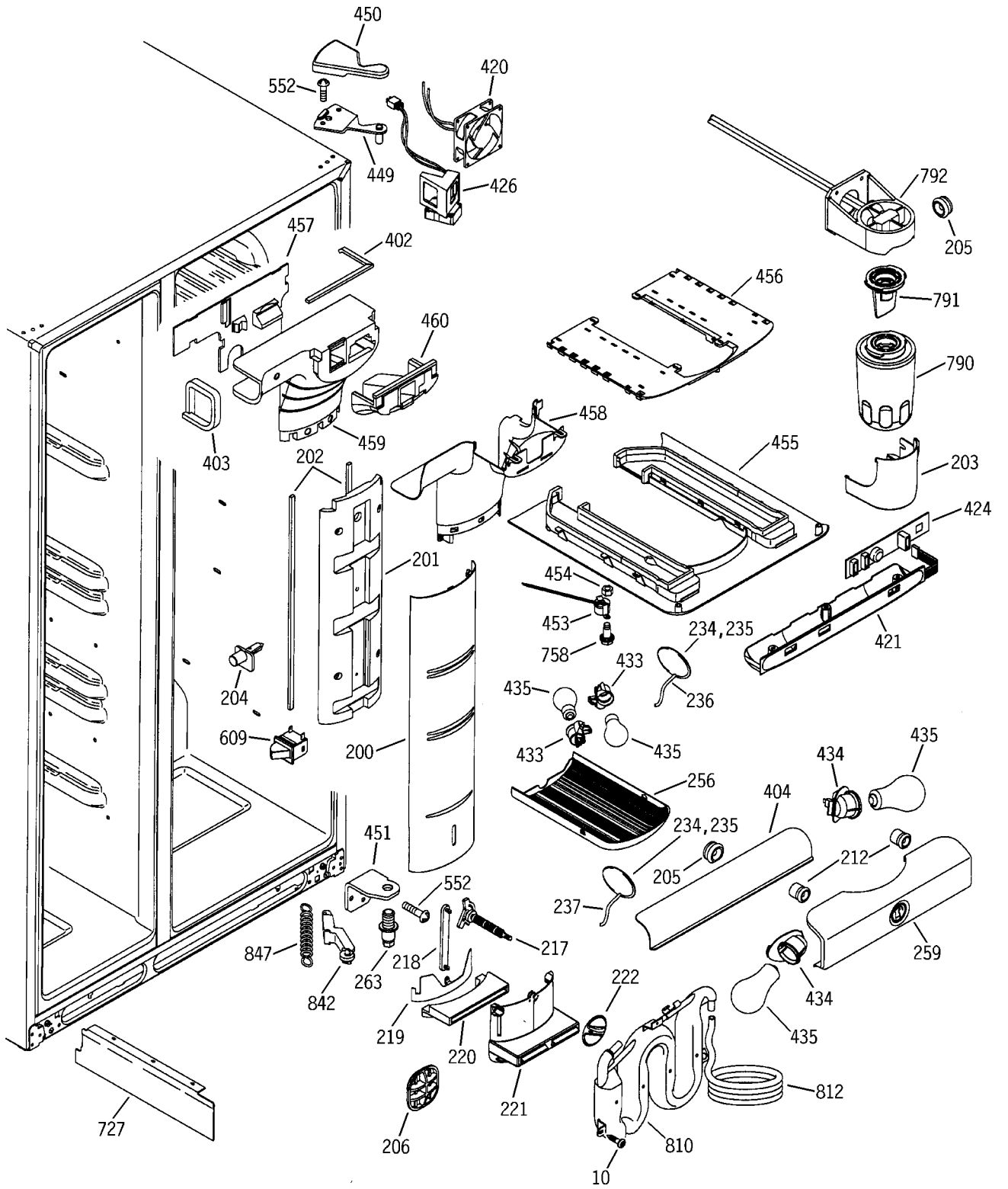

Ref No	Part Number	Description	Qty
10	WR01X10065	SCR 8-18 BA POR 5/8 SS	7
200	WR17X10802	COVER FF TOWER	1
201	WR17X10803	EPS FF TOWER	1
202	WR14X10062	GASKET FF TOWER	2
203	WR17X10800	COVER WATER FILTER	1
204	WR02X10676	FRAME SUPPORT PINS	18
205	WR02X10678	GROMMET	2
206	WR02X10671	GRILLE AIR RETURN	1
212	WR02X10689	GROMMET BASE GRILLE	2
217	WR32X10154	DIAL PAN CHILL	1
218	WR02X10665	LINKAGE PAN CHILL	1
219	WR02X10664	SHUTTER PAN CHILL	1
220	WR02X10644	EPS PAN CHILL	1
221	WR02X10641	DISCHARGE PAN CHILL	1
222	WR02X10666	KNOB PAN CHILL	1
234	WR02X10647	GRILLE SENSOR	3
235	WR02X10668	SHUNT SENSOR	3
236	WR55X10027	SENSOR TEMP FF	1
237	WR55X10028	SENSOR TEMP FF	1
256	WR17X10839	SHIELD LIGHT FF	1
259	WR17X10801	LIGHT SHIELD	1
263	WR02X10648	PIN HINGE BTM ADJ HOLLOW	1
402	WR14X10070	GASKET FF INLET	2
403	WR14X10071	GASKET FF INLET	1
404	WR17X10837	DIVERTER FF AIRFLOW	1
420	WR60X10051	DC FRESH FOOD FAN	1
424	WR55X10039	BOARD ASM TEMP CONTROL	1
426	WR60X10052	DAMPER ASM	1
433	WR02X9391	SOCKET & TERMINAL ASM	3

Ref No	Part Number	Description	Qty
434	WR02X10645	SOCKET LAMP	2
435	STD372402	LAMP 40 W	4
449	WR13X10136	HINGE TOP & PIN ASM	1
450	WR02X10784	COVER HINGE	1
451	WR13X10159	HINGE BTM	1
453	WR09X10052	THERMOSTAT FF LIGHTS	1
454	WR01X10212	NUT 8-32	2
455	WR17X10805	COVER FF TUNNEL ASM	1
456	WR17X10804	BEZEL LIGHT FF	1
457	WR17X10870	EPS BACK FF INLET ASM	1
458	WR17X10896	COVER FF INLET	1
459	WR17X10869	EPS FF INLET ASM	1
460	WR17X10871	EPS BRIDGE FF INLET	1
552	WR01X2022	SCR 12-24 TT OVT .900 S	10
609	WR23X10175	SWITCH LIGHT	1
727	WR17X10820	SEPARATOR AIR HISIDE	1
758	WD02X0323	SCREW 8-32 X 3/8 SPH	2
790	GWF	FILTER CANISTER	1
791	WR02X10577	PLUG BYPASS FILTER	1
792	WR17X10707	FILTER MNT & TUBE ASM	1
810	WR17X10734	WATER TANK & TUBE ASM	1
812	WR17X10732	TUBE PLASTIC	1
842	WR11X10009	LEVER ASM FF	1
847	WR01X2027	SPRING CLOSURE	2

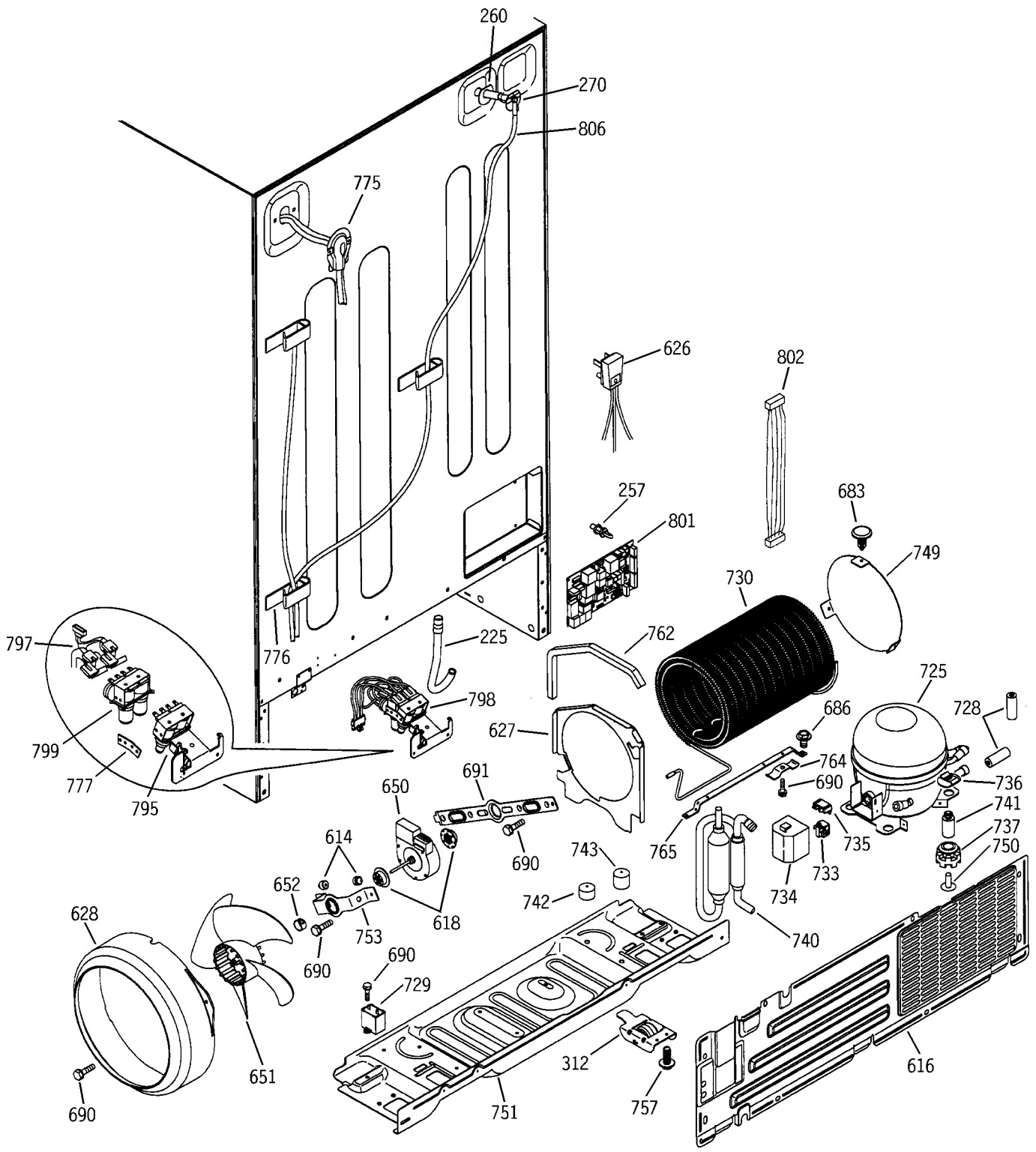

Ref No	Part Number	Description	Qty
225	WR02X10661	TUBE DRAIN	1
257	WR02X10663	STAND OFF	4
260	WR02X9223	GASKET DONUT	1
270	WR02X10564	GROMMET WATER FILL	1
312	WR02X10571	MOBILITY BACK ASM	2
614	WR02X10540	BUMPER LID	4
616	WR82X10071	COVER ACCESS ASM	1
618	WR02X10520	GROMMET COND FAN	2
626	WR01X5278	CLAMP CABLE	3
626	WR23X0108	POWER CORD	1
627	WR17X10691	BAFFLE CONDENSER	1
628	WR17X10726	SHROUD CONDENSER	1
650	WR60X10053	MOTOR DC COND FAN	1
651	WR60X10049	BLADE COND FAN ASM	1
652	WR02X10509	RING COMPRESSION FAN	1
683	WR02X10562	FASTENER PUSH	3
686	WR01X10194	SCR 10-32 TT HXW 5/16 S	5
690	WR01X1466	SCR 8-32 T HXW 3/8 S	8
691	WR02X10593	BRACKET COND FAN (REAR)	1
725	WR87X10042	COMPRESSOR REPL ASM	1
728	WR14X10055	GROMMET TUBING SLIT	2
729	WR62X0079	CAPACITOR	1
730	WR84X10022	CONDENSER REPL ASM	1
733	WR07X10033	PTCR	1
734	WR02X10556	COVER RELAY SNAP (MEI)	1
735	WR08X10025	OVERLOAD	1
736	WR02X8203	CLIP COMPRESSOR MOUNT	4
737	WR02X10099	GROMMET	4
740	WR86X0096	DRYER BIFURCATED XH9	1

Ref No	Part Number	Description	Qty
741	WR01X1779	STUD MTG COMPR	4
742	WR02X10587	SUPPORT CONDENSER	1
743	WR02X10588	SUPPORT CONDENSER	1
749	WR17X10694	BAFFLE COND AIR	1
750	WR01X1786	SCR 10-32 TR T 1/2	4
751	WR17X10693	BASEPLATE HIGH SIDE	1
753	WR02X10521	BRACKET COND FAN (MTG)	1
757	WR01X10193	SCR 10-32 SPECIAL	22
762	WR14X10053	FOAM STRIP SE ADH	1
764	WR02X9000	CLIP, CONDENSER MOUNT	2
765	WR17X10695	BRACKET CONDENSER BAR	1
775	WR17X10796	COVER WATER LINE	1
776	WR02X10686	CLAMP TUBE	3
777	WR02X10370	BRACKET WATER VALVE	1
795	WR57X10023	VALVE ASM WATER	1
797	WR23X10108	HARNESS	1
798	WR57X10026	BRACKET & VALVE ASM	1
799	WR57X10024	WATER VALVE ASM	1
801	WR55X10037	BOARD ASM MAIN CONTROL	1
802	WR23X10178	HARNESS BOARD INDIV	1
806	WR17X10733	TUBE PLASTIC	1